

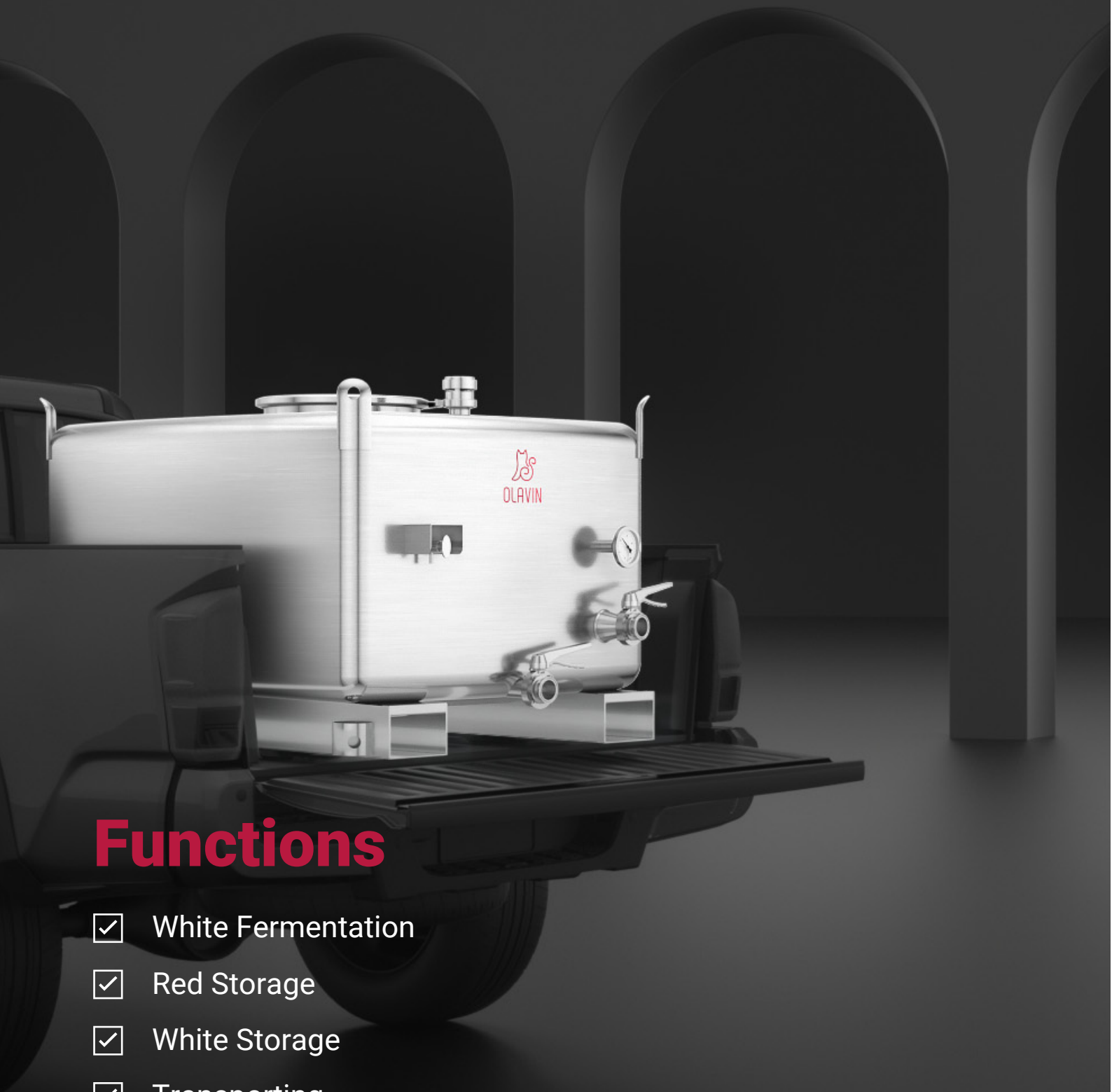

**The best BUDGET tank
for 2021**

Olavin Mini Tanker (Code: L)



Functions







- White Fermentation
- Red Storage
- White Storage
- Transporting
- Stacking when full
- Forkable
- Red Fermentation OPTIONAL

25%+ Space Saving

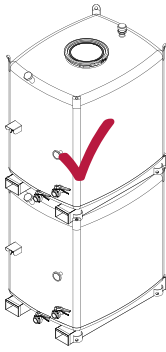
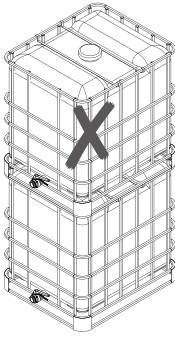



Olavin Mini Tanker VS IBC Tank

<p>Stackable When Full</p>	 <p>Yes</p>	 <p>No</p>
<p>Cleaning Method</p>	 <p>By CIP</p>	 <p>By hand</p>
<p>Cleaning Time</p>	 <p>Short</p>	 <p>Long</p>
<p>Cleaning Water Use</p>		
<p>Lifetime</p>	<p>2021</p> <p>↓</p> <p>20 years</p> <p>↓</p> <p>2041</p>	<p>2021</p> <p>↓</p> <p>3 years</p> <p>↓</p> <p>2024</p>

10 Key Benefits Olavin Will Bring You

- 1 **★ Dairy Grade Finish ★**
'Olavin Surpro Finish' (ultra-smooth dairy grade internal weld finish) will help reducing your tank cleaning time up to 60%.
- 2 **★ Good Flow Jacket ★**
Specialized handmade 'Olavin Dypple Jacket' enables an even spread of cool over the entire tank. You get the full benefit of every drop of glycol.
- 3 **★ Charge-Free Customization ★**
There is No Extra Charge for personalizing your tanks.
- 4 **★ 100% Handcrafted ★**
All welds are handcrafted. It offers more precision & better weld seam performance.
- 5 **★ Seismic Engineering ★**
We take seismic design to protect people & wine from potentially earthquake loss.
- 6 **★ American Design ★**
If you are like most Americans, you will prioritize durability, versatility & functionality. Olavin tank is durable, versatile, and practical.
- 7 **★ All Stainless Steel ★**
All visible parts are made from stainless steel. Carbon steel is more susceptible to rust and corrosion, thus it is not an option from Olavin.
- 8 **★ Beautiful & Attractive Appearance ★**
Shiny tank surface instantly makes your winery look brighter and more beautiful.
- 9 **★ 2 Year Replacement Guarantee ★**
Fittings and accessories installed on an Olavin tank have a 2 year's warranty from the date of acceptance.
- 10 **★ 20 Year Workmanship Guarantee ★**
Tank bodies and structures come with a 20-year guarantee on workmanship and materials.

Olavin Mini Tanker (Code L) Technical Specifications

- **Product Code:** L
- **Inner Surface:** 2B
- **Outer Surface:** Oil brushed
- **Inner Weld Seam Treatment:** Olavin Surpro Finish ($Ra \leq 24\mu\text{in}$)
- **Outer Weld Seam Treatment:** Retain weld bead height, pickled and passivated
- **Jacket:** Olavin Dypple Jacket
- **Jacket Working Pressure:** 43.5PSI
- **Material:**
 - Standard** All SS304
 - Olavin Plus** All wet parts: SS316

- **Dimensions:** V W L H_1 H (Please refer to Page 8)
 Rated Volume Width Length Shell Height Total Height

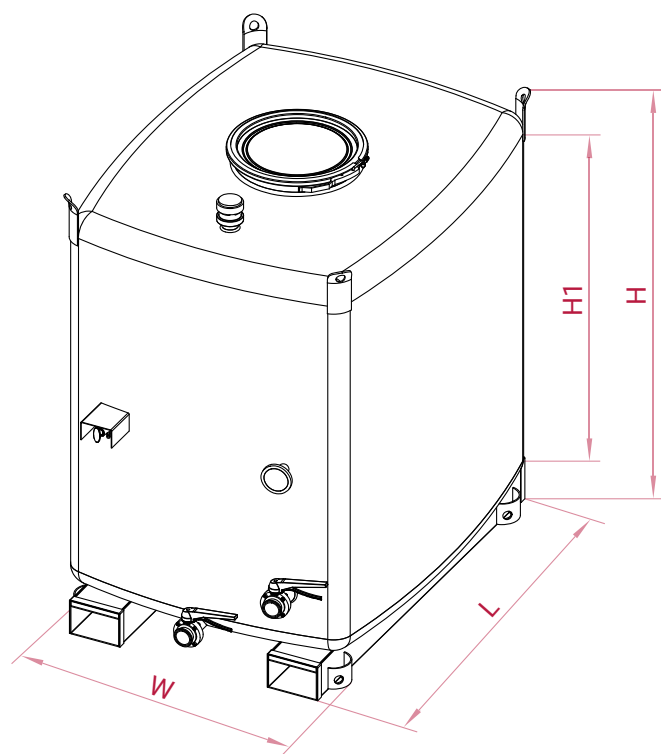

Olavin Mini Tanker (Code L) Technical Specifications



Top Entry

- Size: 400mm / [1'-3 3/4"]
- ★ Detachable Lid
- ★ Seal on Lid
- ★ All parts of the manhole are electrolytically polished, except for the silicone seal
- ★ All parts of the manhole are made of stainless steel, except for the silicone seal

Standard	Olavin Plus
✓	✓



Multi-purpose Lug

- ★ Function 1: Introducing the top tanker to the right position when stacking
- ★ Function 2: Stopping top tanker from moving back and forth
- ★ Function 3: Tying down points for the tankers during transportation
- ★ Function 4: Using as lifting lugs

✓	✓
---	---



Stainless Steel Vent

- Vent Size: 2" female DIN
- Fitting Port Size: 2" male DIN
- ★ All vent parts are made from stainless steel
- ★ Hygienic design, removable and washable
- ★ Minimum life of 10 years

✓	✓
---	---



Anti-collision Structure

- ★ Preventing valves from being destroyed during fork operation

✓	✓
---	---



Sample Valve

- Connection Type: 1" welded type
- ★ Anti-foaming design: wine does not foam in sample bottle after comes out from tank
- ★ Anti-aerating design: it is not possible air goes into tank when sampling

Standard	Olavin Plus
✓	✓

Olavin Mini Tanker (Code L) Technical Specifications

Standard	Olavin Plus
<input checked="" type="checkbox"/>	<input checked="" type="checkbox"/>



Thermometer & Thermowell

- Thermometer: dual scale in Fahrenheit and Celsius
- Thermometer Range: 14°F-140°F
- Thermowell Connection Type: 1/2" NPSC female thread
- Thermowell stem depth into tank: 11 3/4"



Racking Valve

- Connection Type: 2" Tri-clamp
- Racking takes 2"/3" concentric reducer
- Valve Type: butterfly valve, clamp connection at outer end, easy to clean
- ★ Structure: very robust, not easily deformed
- ★ Free from liquid retaining

<input checked="" type="checkbox"/>	<input checked="" type="checkbox"/>
-------------------------------------	-------------------------------------



Drainage Valve & Sump

- Connection Type: 2" Tri-clamp
- Valve Type: butterfly valve, clamp connection at outer end, not easy to block
- ★ Sump internal surface is seamless & smooth, enables a fast and complete drainage
- ★ Free from liquid retaining

<input checked="" type="checkbox"/>	<input checked="" type="checkbox"/>
-------------------------------------	-------------------------------------



Olavin Dypple Jacket™

- Position: at tank rear

Olavin Dypple Jacket™ VS Laser Jacket

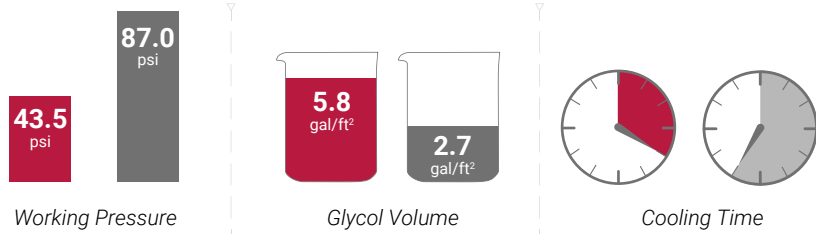

- The lower, the better
- The more, the better
- The shorter, the better

<input checked="" type="checkbox"/>	<input checked="" type="checkbox"/>
-------------------------------------	-------------------------------------

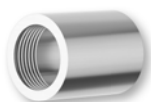

Jacket Inlet & Outlet

- Size: 1" NPSC female thread

Standard	Olavin Plus
<input checked="" type="checkbox"/>	<input checked="" type="checkbox"/>

Olavin Mini Tanker (Code L) Technical Specifications

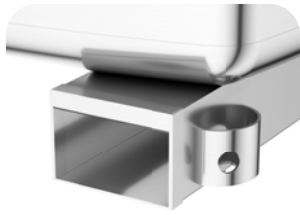

Fork Pocket & Positioner

- ★ Reinforced Fork Pockets: durable for 20 years
- ★ A perfect fit of positioner & multi-purpose lug

Standard	Olavin Plus
<input checked="" type="checkbox"/>	<input checked="" type="checkbox"/>



Free Spare Parts

- ★ Spare tri-clamp fittings for sample valve, racking and drainage valve
- ★ Spare gaskets for racking and drainage valve
- ★ Spare seals for top entry, racking oval door & mash door

Standard	Olavin Plus
<input checked="" type="checkbox"/>	<input checked="" type="checkbox"/>



CIP Assembly

- Connection Type: 1.5" Tri-clamp
- ★ 40% faster cleaning to increase your productivity
- ★ 360° full wetting
- ★ Saving 40% water use

Standard	Olavin Plus
<input type="checkbox"/>	<input checked="" type="checkbox"/>



Make it Yours

- ★ Your logo is strengthened on the shiny stainless steel surface
- ★ New engraving technology, no glue use, never fading

Standard	Olavin Plus
<input type="checkbox"/>	<input checked="" type="checkbox"/>

Olavin Mini Tanker (Code L) Capacities and Dimensions

Volume Gallon	W inch	L inch	H1 inch	H inch
264	44	58	24	36
396	44	58	39	51
476	44	58	48	60
528	44	58	53	64
581	44	58	59	71

W - Max. Width
L - Max. Length
H1 - Shell Height
H - Total Height

* Customization is available.

Exclusive Offers for Unified

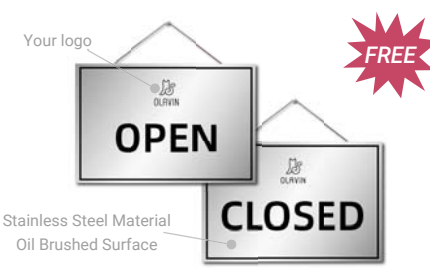

'Open & Close' Tag
(Worth **\$120**)

AS LONG AS YOU CONTACT OLAVIN
during Unified show, we will provide a
FREE 'open & close' tag for you



CIP Assembly
(Worth **\$500**)

For **ANY OLAVIN BOOTH VISITOR**
who makes happen a purchase
before April 30, 2021,
we will supply a CIP assembly
FREE OF CHARGE.

EMAIL US TO GET THEM NOW



Andrew

andrew@revolutionequipmentsales.com



Adam

acaterino@revolutionequipmentsales.com



Becky

becky@olavin.com



Tanks, Catwalks & Drains



Representing Olavin in the US