

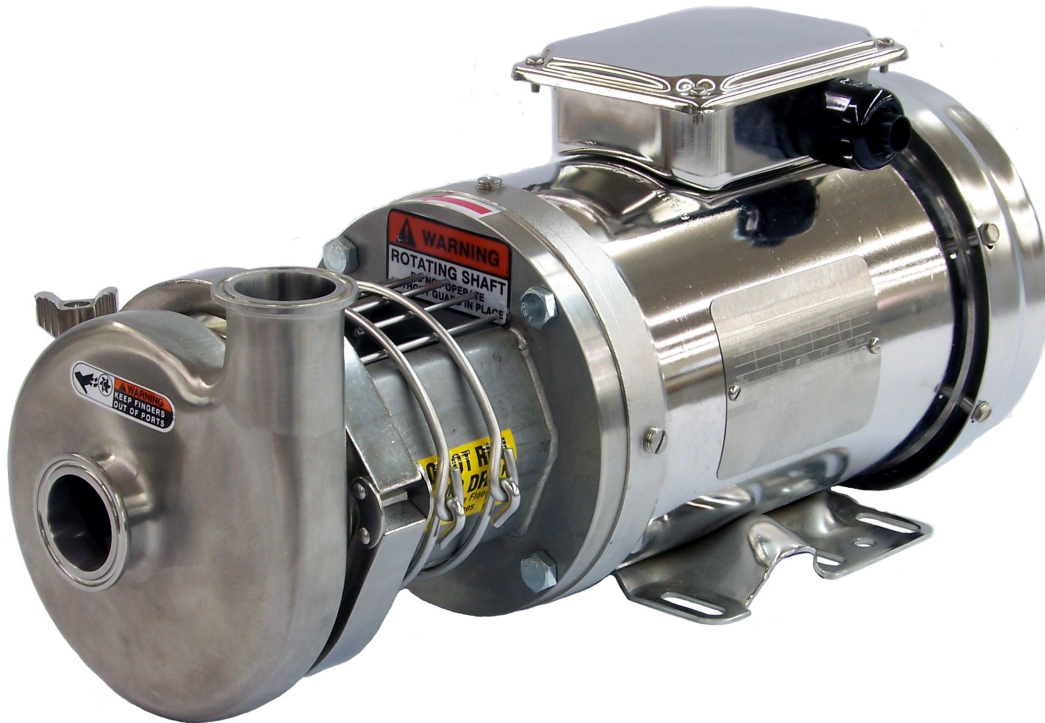

# TOP-FLO® Centrifugal Pump Model TF-C Series Catalog



Stainless Steel Flow Control Equipment for the Food,  
Beverage, Dairy, Cosmetics, Pharmaceutical,  
Biotechnology, and Electronics Processing Industries

**STEEL & O'BRIEN IS AT YOUR SERVICE**

585-492-5800

[sales@steelobrien.com](mailto:sales@steelobrien.com)

[www.steelobrien.com](http://www.steelobrien.com)

SIMPLIFYING SANITARY THROUGH SUPERIOR SERVICE.™

# TOP-FLO®

The centrifugal pump for the process industry.

## Contents

Introduction .....	IFC
Ordering Information .....	1
C-Series Specification .....	2
Pump Features .....	3
Pump Sizing Guide .....	4
Head Capacity Curve Charts.....	5-22
Viscosity and Specific Gravity Table .....	23
Friction Loss Table .....	24
Pump Dimensions .....	25
TOP-FLO® Pump Replacement Kits .....	26
TOP-FLO® Pump Dolly.....	27
TOP-FLO® TL60ARV Air Relief Valve .....	28

## Introduction

The TOP-FLO® name represents the finest in sanitary process equipment. TOP-FLO® pumps have been designed to offer efficient transfer of product over a wide range of head and viscosity conditions. TOP-FLO® pumps are easy to install, clean, and operate.

This catalog will answer many of the questions you may have regarding TOP-FLO® pumps. If you require additional information, a representative will be happy to assist you and can be reached at 585-492-5800.

TOP-FLO® pumps are suitable for use in CIP (clean-in-place) installations. This feature enables easy self-cleaning with no dismantling or take-down. Sanitizing of all product contact areas is automatic.

All TOP-FLO® pumps are available in standard inlet sizes and outlet sizes. In addition, enlarged inlet sizes are available for special applications.

# Pump Ordering Information

Determining the model number of your pump is easy as 1-2-3-4.

TF-C



①

216



②

M



③

D



④

## ① PUMP SERIES

TF-C Close Coupled

②

## PUMP MODEL

TF-C100, TF-C114, TF-C216, TF-C218, TF-C328

Note:

- TF-C Series furnished without legs unless otherwise specified on order.
- Casing Gaskets: BUNA (Standard). If other type is required, specify on order.
- Enlarged inlet: When ordering pump with enlarged inlet state inlet size, i.e., TF-C218MD with 3" inlet.

③

## PORT CONNECTIONS

M - Clamp (Standard)

T - Acme Bevel Seat Thread

S - NPT Female Thread

F - Flanged

W - Weld

## TYPE OF SEAL/STANDARD MATERIAL:

④

- D - External balanced sanitary seal
- DG - External balanced sanitary seal w/clamped insert
- E - Water cooled balanced double seal
- F - External balanced seal w/cascading water



**Motor Data** is not included as part of 4-step ordering number.

Provide the following information:

- Horsepower and RPM
- Electrical phase and voltage

- TEFC is standard

If motor is furnished from another source, supply the following:

- Horsepower
- RPM
- NEMA frame size

Remember to order needed accessories:

- Seal Kits and Parts
- Gaskets
- Clamps
- Hangers
- Air Relief Valves
- Check Valve
- Butterfly Valves
- Ball Valves
- Fittings

# TOP-FLO® TF-C Series Centrifugal Pumps

## PUMP SPECIFICATIONS:

Capacity: 10gpm to 600gpm  
 Pressure: 135 PSIG  
 Viscosity: 200cp  
 Temperature: 212°F

Model No.	TF-C100	TF-C114	TF-C216	TF-C218	TF-C328
Inlet	1-1/2	1-1/2 or 2	2 or 2-1/2	2 or 3	3 or 4
Outlet	1	1-1/2	1-1/2	1-1/2	2
Max. Imp.	3.68	4	6	8	8

## PUMP SPECIFICATIONS

### Pump Casings:

- Volute type - Standard
- Inlet-oversizing as noted in chart above

### Pump Connections:

- |                     |                    |
|---------------------|--------------------|
| <b>SANITARY:</b>    | <b>INDUSTRIAL:</b> |
| • Clamp             | • Threaded         |
| • Bevel Seat (ACME) | • Flanged          |

### Pump Construction Materials:

- All wetted parts - 316L SS
- Seals - Carbon (other seals available)
- Casing Gasket - BUNA (Standard)
- FKM, EPDM, and PTFE are available

### Pump Finishes:

- Polished or Electropolished
- 32R<sub>a</sub> standard

### Pump Seals:

- Available in D, DG, E, and F styles

### Motor, Electrical:

- 3 Phase - 230/460 volts - 1750 & 3500 rpm
- Single Phase - 115/230 volts - 1750 & 3500 rpm

### Motor Housings:

- TEFC (Totally Enclosed Fan Cooled)
- Washdown Duty
- Other styles available on request

## SEAL SPECIFICATIONS

### **TYPE D External Balanced Seal (Sanitary)**

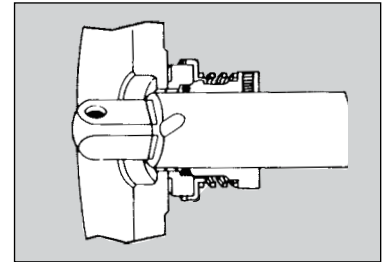

This versatile seal has numerous applications but yet is extremely durable. Dairy products, soft vegetables, beverages, and even acid cleaning solutions and detergents are among the recommended uses.

### **TYPE DG External Balanced Seal with Clamped-in Seat (Sanitary)**

The DG seal uses the standard Type D rotating seal components with a reversible silicon carbide, tungsten carbide or ceramic seat. Typical applications include liquid sugar, beverage syrup, chocolate and abrasive products.

### **TYPE E Water Cooled Balanced Double Seal (Sanitary)**

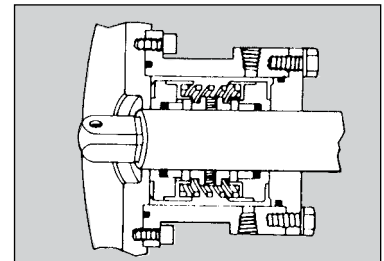

Type E is designed to withstand heavy duty vacuum applications (to 28" Hg), tacky products, slurries, or pumped products up to 212°F. The seal chamber can be pressurized to permit use of drain piping for coolants and sealants. Coolant or sealant can be circulated through the seal chamber under very low pressure when used to cool the seal face or seal against vacuum.

### **TYPE F – (Sanitary)**

Seal same as Type D seal except includes a water cascade (not shown). All sanitary seals meet 3A accepted practices.

### **TYPE IS Internal seal for C114**

# TOP-FLO<sup>®</sup> pumps are top performers using numerous features

**SUPERIOR SEAL:** Provides a longer life and less downtime. High grade finish reduces pressure at sealing surface results in less wear and greater efficiency.

**TYPE F SEAL:** Water cascade attachment is recommended for pumping tacky or hot products up to 200° F, and for vacuum applications to 14" Hg.

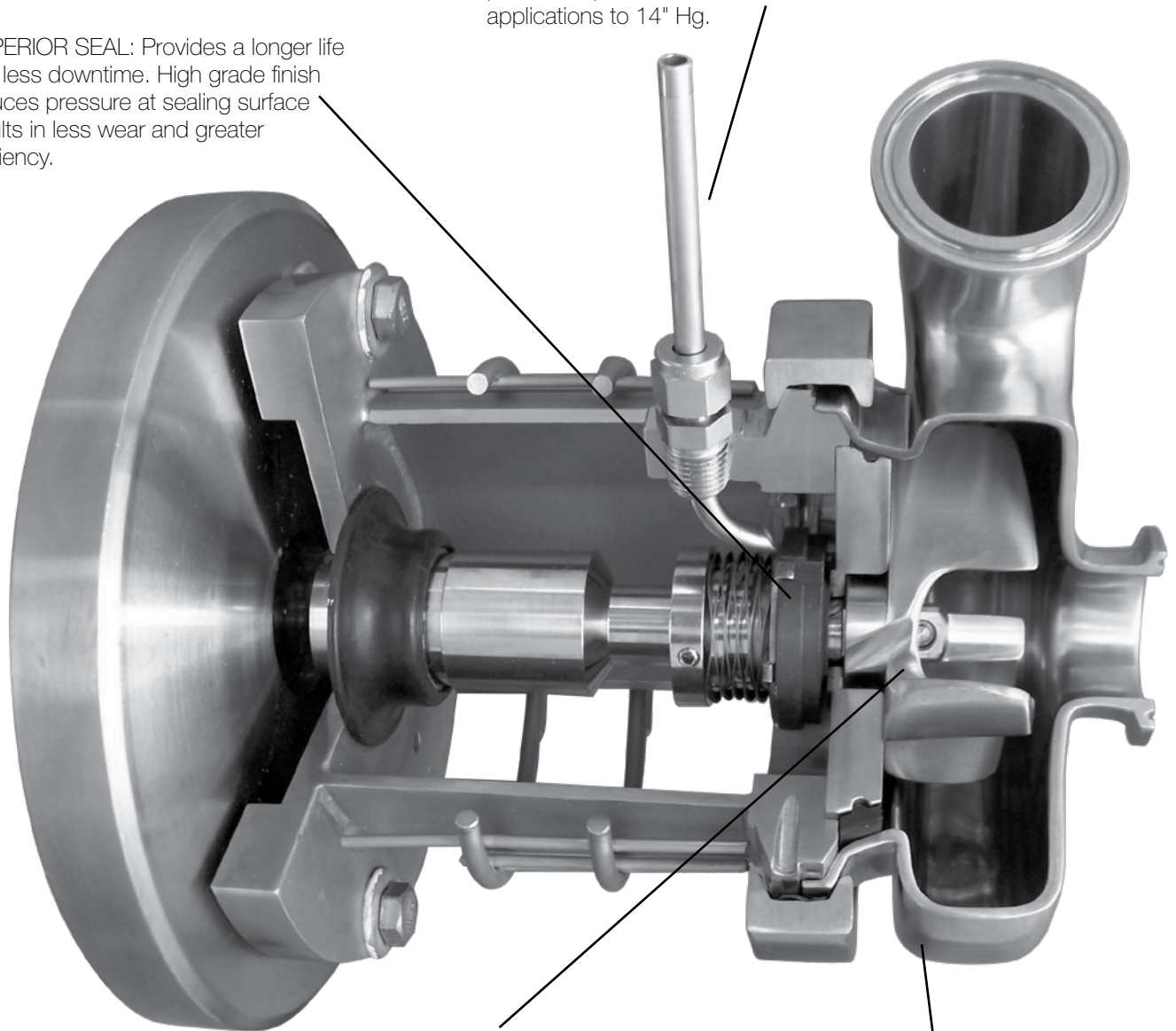

**NO DISASSEMBLY FOR CLEANING:** Unique groove-in-shaft design directs sanitizer to all critical areas. A must for clean-in-place applications.

**CASING:** Finely polished casing suitable to meet numerous requirements. Casing available in a wide selection of port connections to meet a variety of piping systems.

# TOP-FLO<sup>®</sup> Pump Sizing Application Data

## Use of a Pump Curve Chart

The curve chart is the best resource to use when selecting the proper impeller and motor for applications in the food, dairy, beverage, pharmaceutical and cosmetic industries. The curve chart enables the user to determine how a pump will perform at different impeller sizes and motor speeds.

Operating at 1750 RPM and 3500 RPM, curves have been listed for the TOP-FLO<sup>®</sup> TF-C100, TF-C114, TF-C216, TF-C218, and TF-C328 centrifugal pumps on the following pages. An instructional chart is listed below.

- Note:**
- Column #1 on the left shows head in feet
  - Column #2 at the bottom shows gallons per minute
  - Impeller sizes are listed on curve line
  - Motor horsepower listed on diagonal serrated lines
  - NPSH required is #3 and listed at the bottom of chart

**Example:** On the curve listed below, find the impeller size and horsepower of motor for 75 GPM against total head pressure of 40'.

Column #1

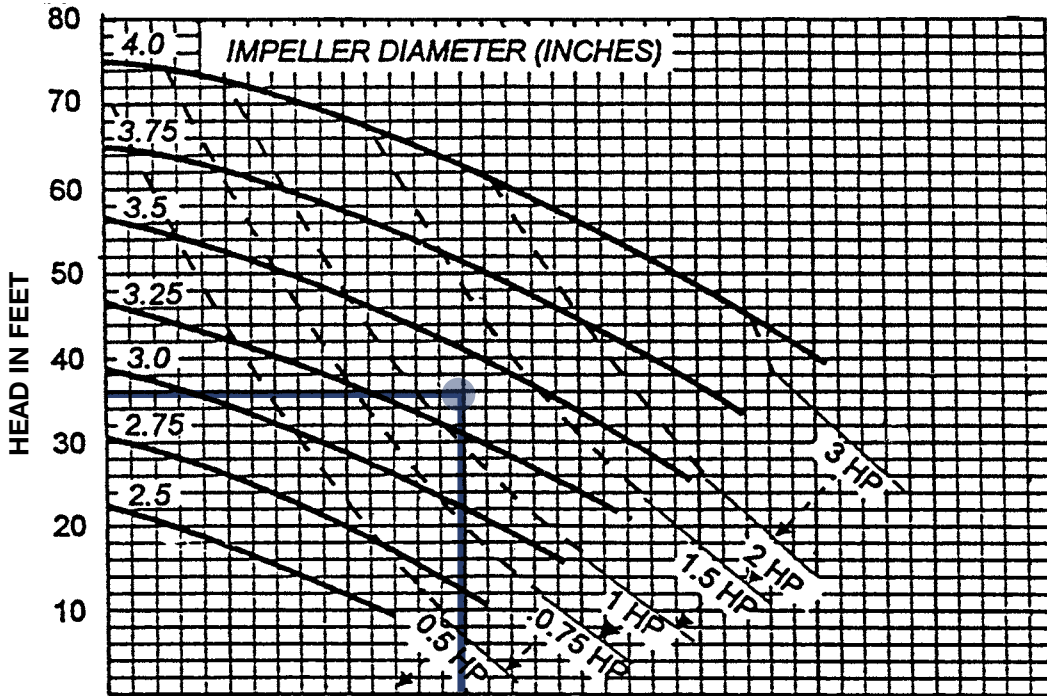

**Answer to example:**

1. To determine duty point:  
First, find the 35' of head in column #1. Second, find the 75 gallon per minute in column #2. Then, trace the 35' of head mark to the right until it intersects the 75 GPM line.
2. To determine impeller diameter. The duty point falls between the 3.25 and 3.5 impeller curve lines. Always choose the curve line above the duty point. In this case it would be 3.5.
3. To determine NPSHR (Net Positive Suction Head Required): Use the NPSHR graph and plot the intersection point of 75 GPM. Follow horizontally to the left. It reads 9'. (This will be Net Positive Suction Head Required.)
4. You will see at this point a 3.25 impeller and a 1-1/2 horsepower motor is required.

Note: NPSHA (Net Positive Suction Available) must be  $>$  or  $=$  NPSHR (Net Positive Suction Head Required).

Column #2

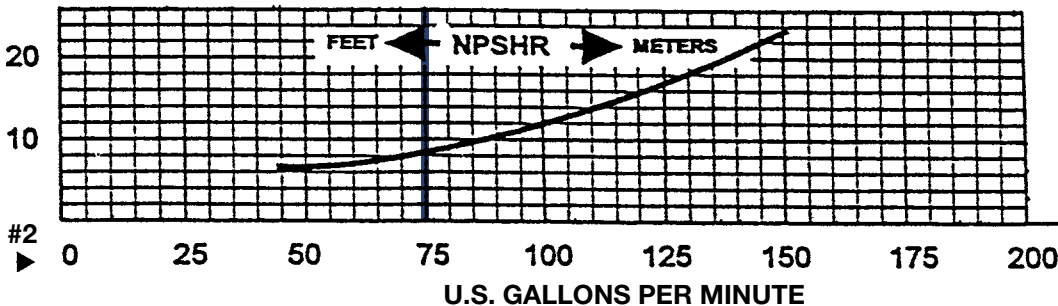

# TOP-FLO<sup>®</sup> TF-C Series Centrifugal Pumps

## Capacity Curves

Based on water at 70°F (22°C)

**Model: TF-C100**  
**60 Hz                      1750 RPM**  
**Size: 1-1/2 x 1 x 3-11/16**

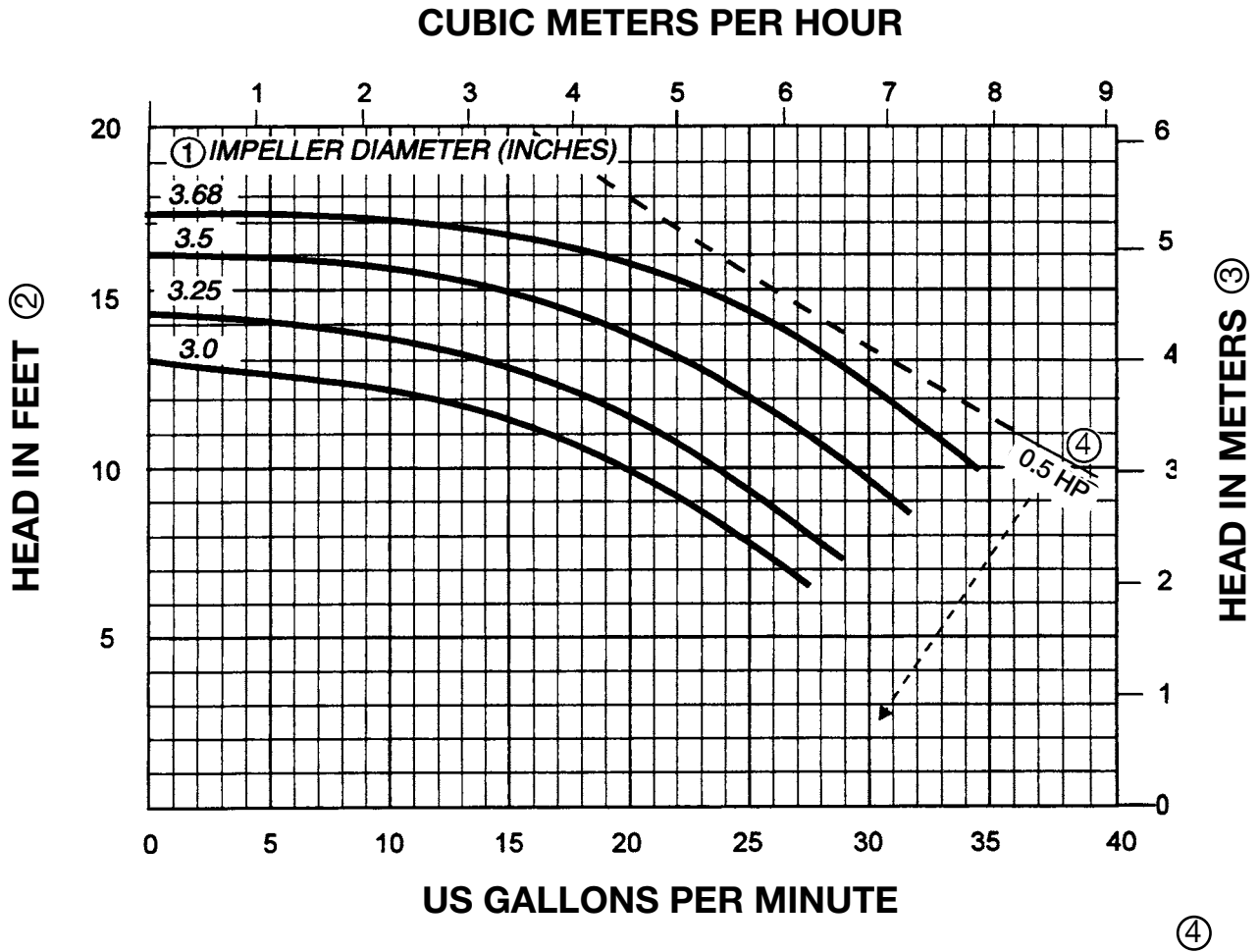

- NOTES:**
- ① Impeller diameters available in 1/16 inch increments
  - ②  $PSI = \frac{\text{Head in Feet} \times \text{Specific Gravity}}{2.3}$

- ③  $Kg/cm^2 = \frac{\text{Head in Meters} \times \text{Specific Gravity}}{10}$
- ④  $HP \times 0.746 = Kw$

# TOP-FLO® TF-C Series Centrifugal Pumps

## Capacity Curves

Based on water at 70°F (22°C)

Model: TF-C114

60 Hz

1750 RPM

Size: 1-1/2 x 1-1/2 x 4

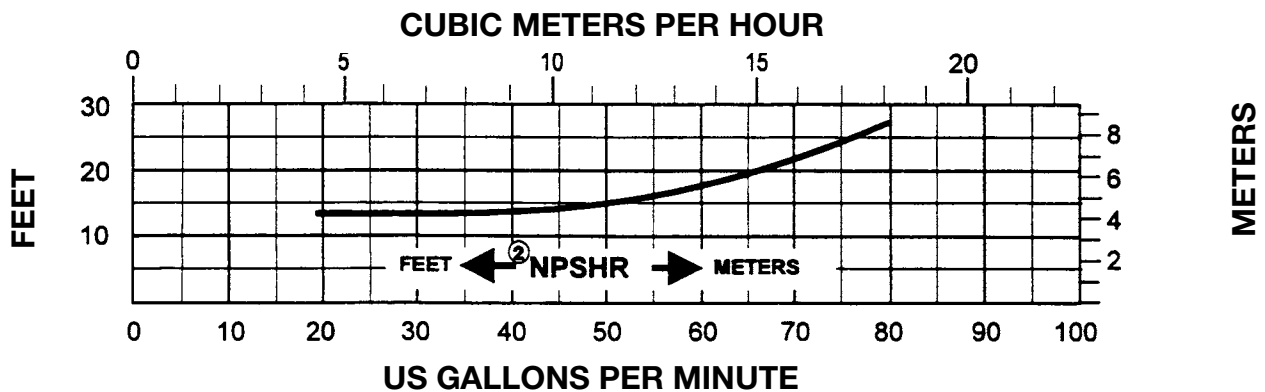
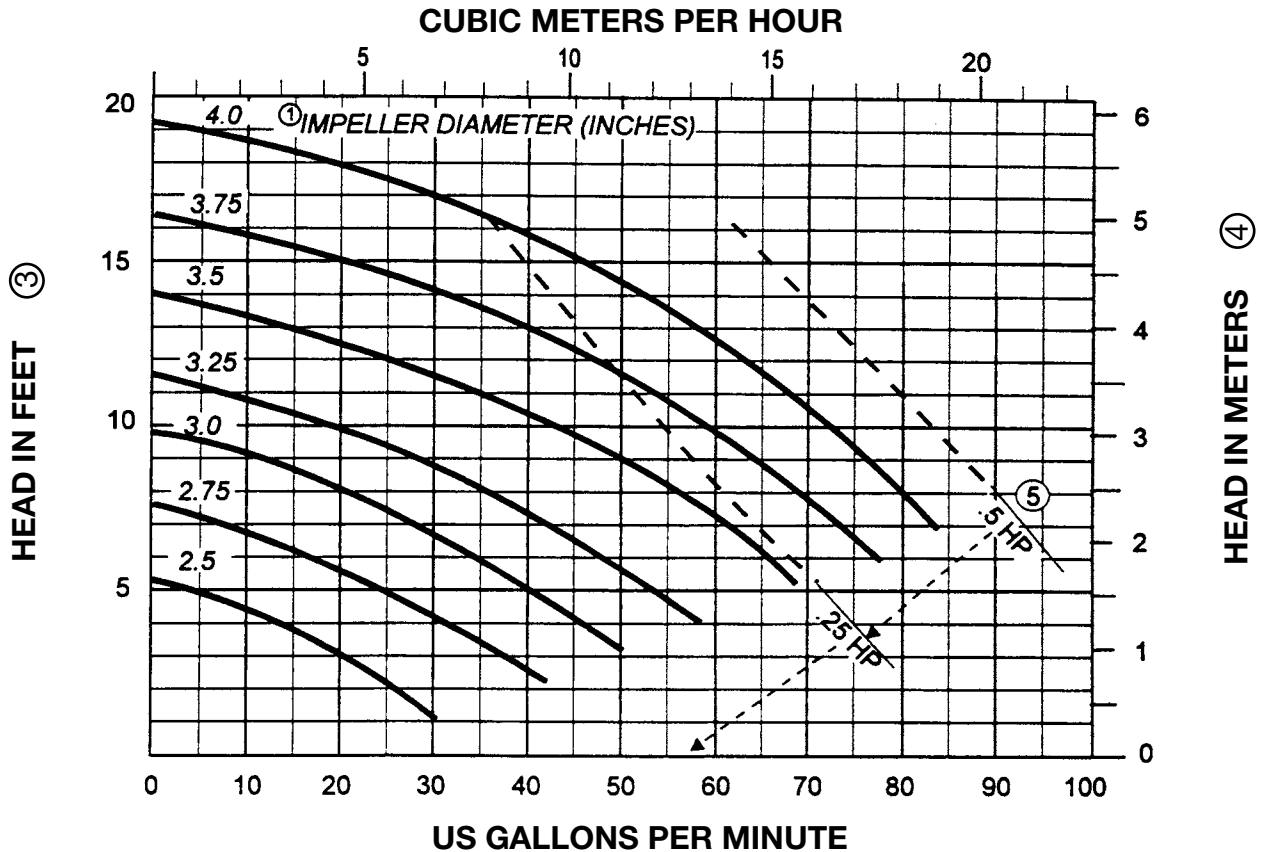

**NOTES:**

① Impeller diameters available in 1/4 inch increments

④  $\text{Kg/cm}^2 = \frac{\text{Head in Meters} \times \text{Specific Gravity}}{10}$

② NPSHR is shown for maximum impeller diameter

⑤  $\text{HP} \times 0.746 = \text{Kw}$

③  $\text{PSI} = \frac{\text{Head in Feet} \times \text{Specific Gravity}}{2.3}$

# TOP-FLO<sup>®</sup> TF-C Series Centrifugal Pumps

## Capacity Curves

Based on water at 70°F (22°C)

Model: TF-C114

60 Hz

1750 RPM

Size: 2 x 1-1/2 x 4

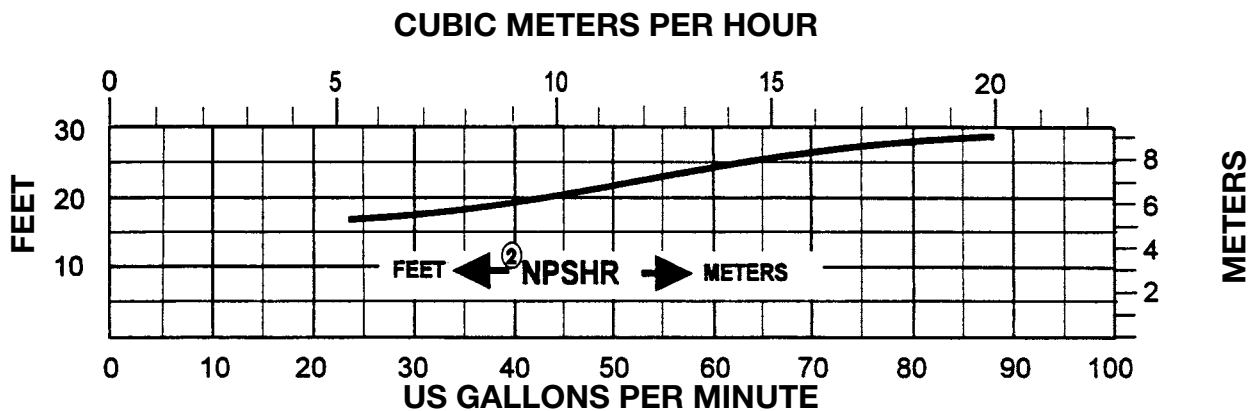
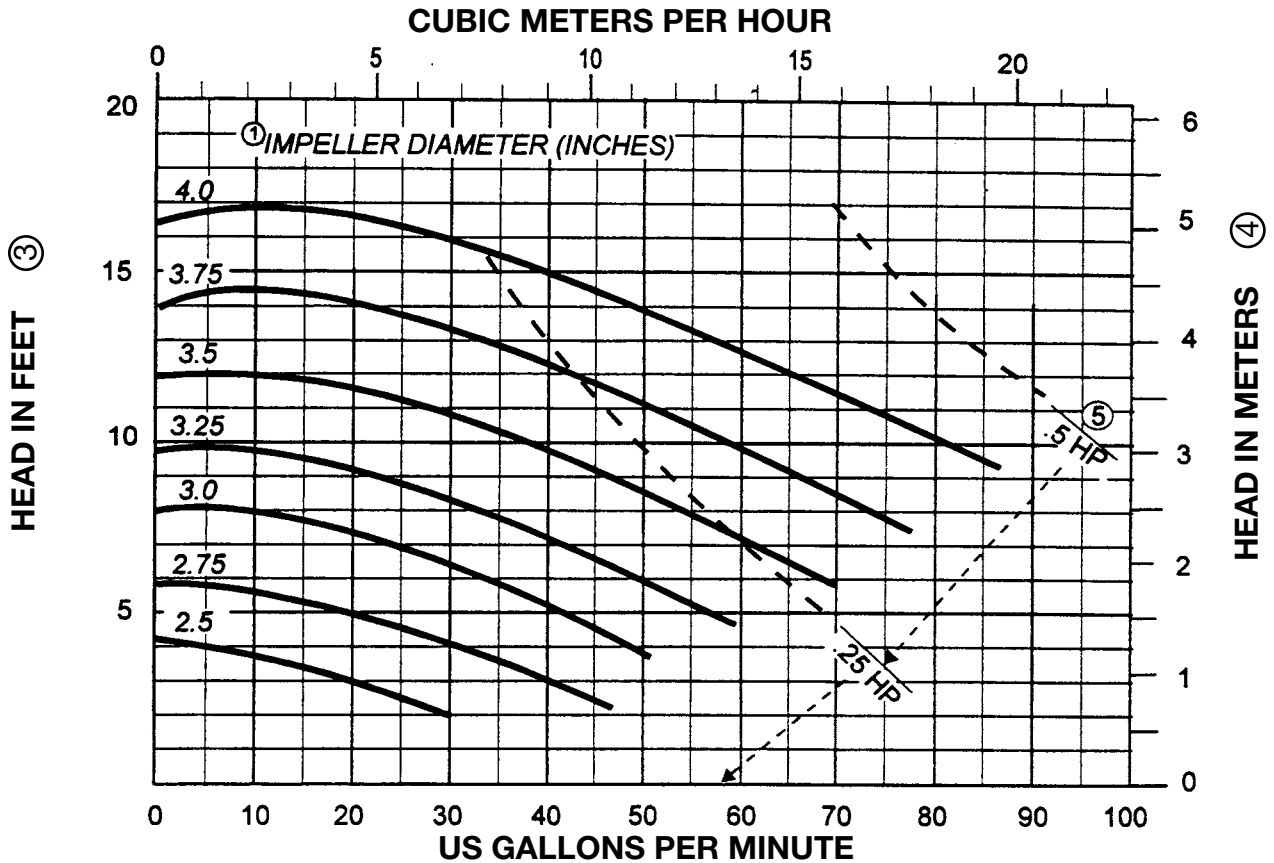

**NOTES:**

① Impeller diameters available in 1/16 inch increments

④  $\text{Kg/cm}^2 = \frac{\text{Head in Meters} \times \text{Specific Gravity}}{10}$

② NPSHR is shown for maximum impeller diameter

⑤  $\text{HP} \times 0.746 = \text{Kw}$

③  $\text{PSI} = \frac{\text{Head in Feet} \times \text{Specific Gravity}}{2.3}$

# TOP-FLO® TF-C Series Centrifugal Pumps

## Capacity Curves

Based on water at 70°F (22°C)

Model: TF-C216

60 Hz

1750 RPM

Size: 2 x 1-1/2 x 6

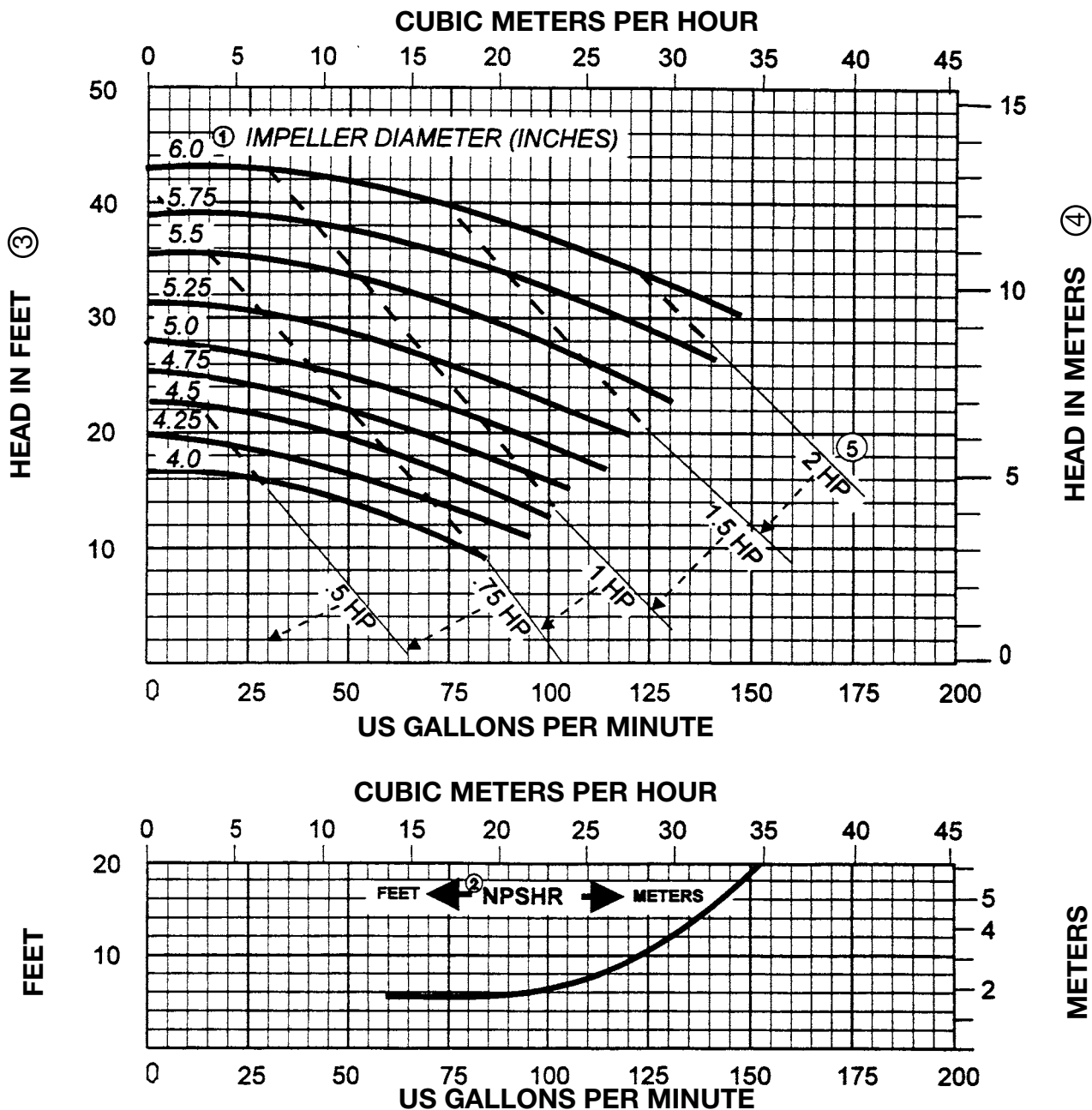

**NOTES:**

① Impeller diameters available in 1/4 inch increments

④  $\text{Kg/cm}^2 = \frac{\text{Head in Meters} \times \text{Specific Gravity}}{10}$

② NPSHR is shown for maximum impeller diameter

⑤  $\text{HP} \times 0.746 = \text{Kw}$

③  $\text{PSI} = \frac{\text{Head in Feet} \times \text{Specific Gravity}}{2.3}$

# TOP-FLO<sup>®</sup> TF-C Series Centrifugal Pumps

## Capacity Curves

Based on water at 70°F (22°C)

Model: TF-C216

60 Hz

1750 RPM

Size: 2-1/2 x 1-1/2 x 6

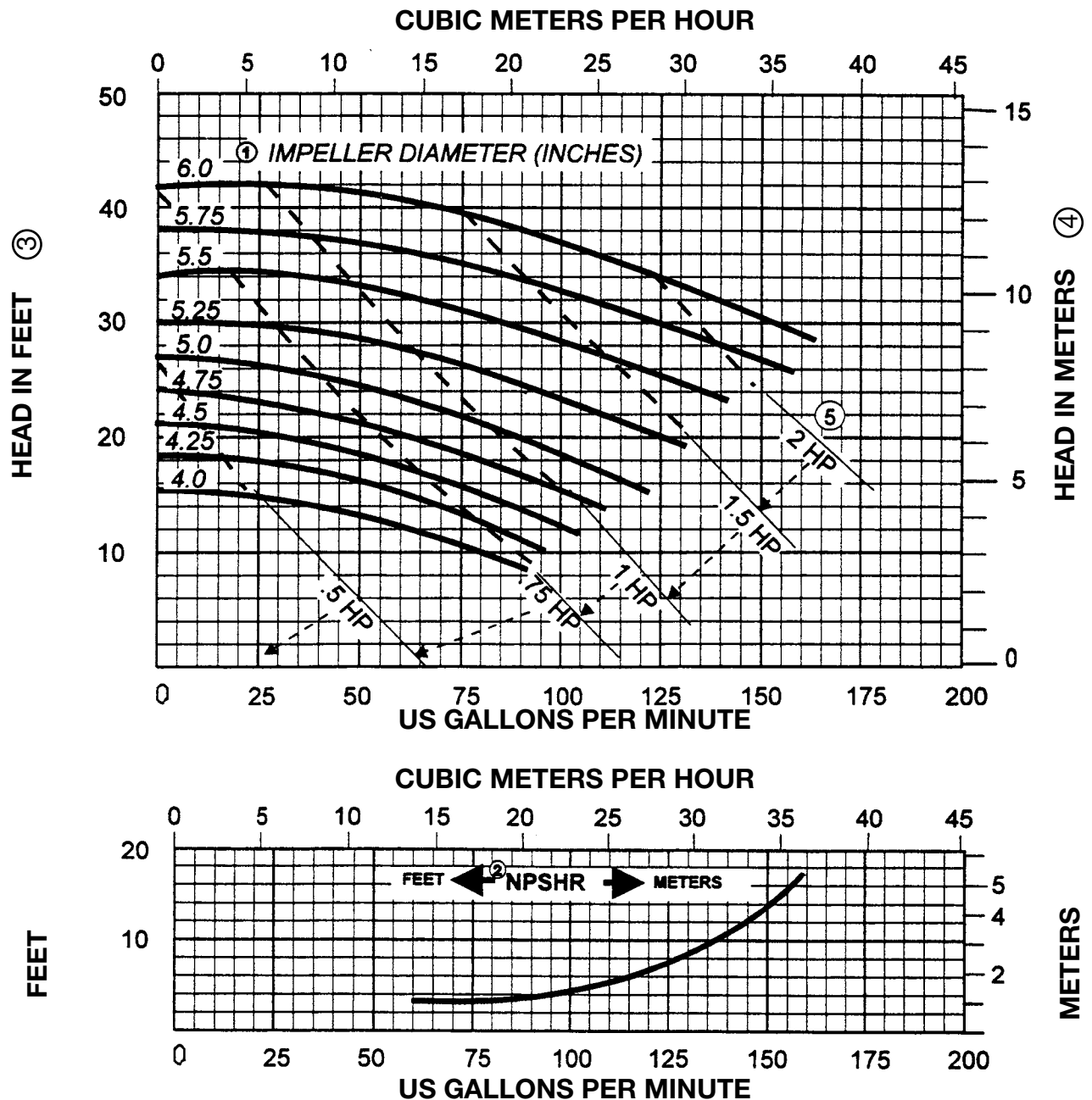

### NOTES:

① Impeller diameters available in 1/4 inch increments

④  $\text{Kg/cm}^2 = \frac{\text{Head in Meters} \times \text{Specific Gravity}}{10}$

② NPSHR is shown for maximum impeller diameter

⑤  $\text{HP} \times 0.746 = \text{Kw}$

③  $\text{PSI} = \frac{\text{Head in Feet} \times \text{Specific Gravity}}{2.3}$

# TOP-FLO® TF-C Series Centrifugal Pumps

## Capacity Curves

Based on water at 70°F (22°C)

Model: TF-C218

60 Hz

1750 RPM

Size: 2 x 1-1/2 x 8

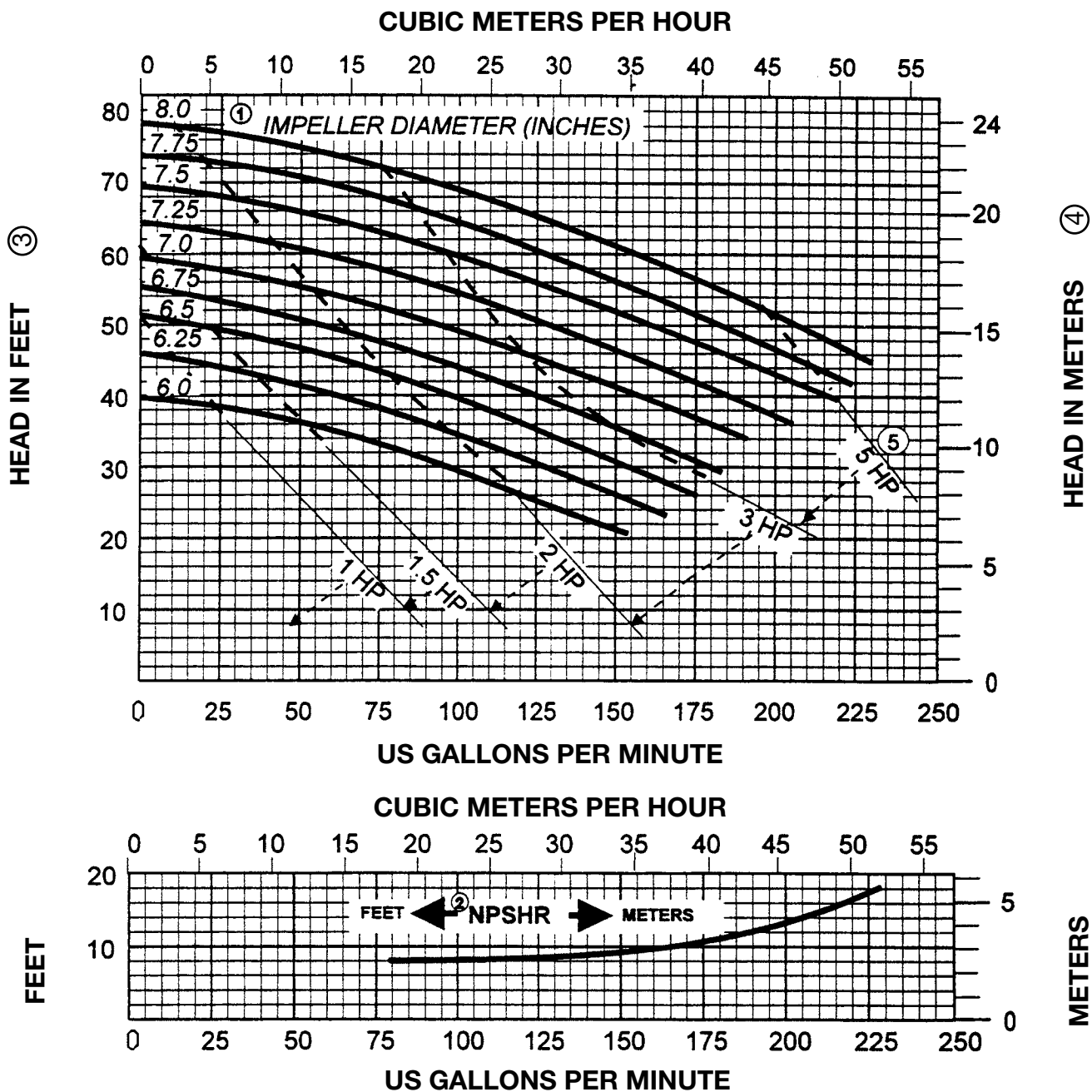

### NOTES:

- ① Impeller diameters available in 1/4 inch increments
- ② NPSHR is shown for maximum impeller diameter
- ③  $PSI = \frac{\text{Head in Feet} \times \text{Specific Gravity}}{2.3}$
- ④  $Kg/cm^2 = \frac{\text{Head in Meters} \times \text{Specific Gravity}}{10}$
- ⑤  $HP \times 0.746 = Kw$

# TOP-FLO<sup>®</sup> TF-C Series Centrifugal Pumps

## Capacity Curves

Based on water at 70°F (22°C)

Model: TF-C218

60 Hz

1750 RPM

Size: 3 x 1-1/2 x 8

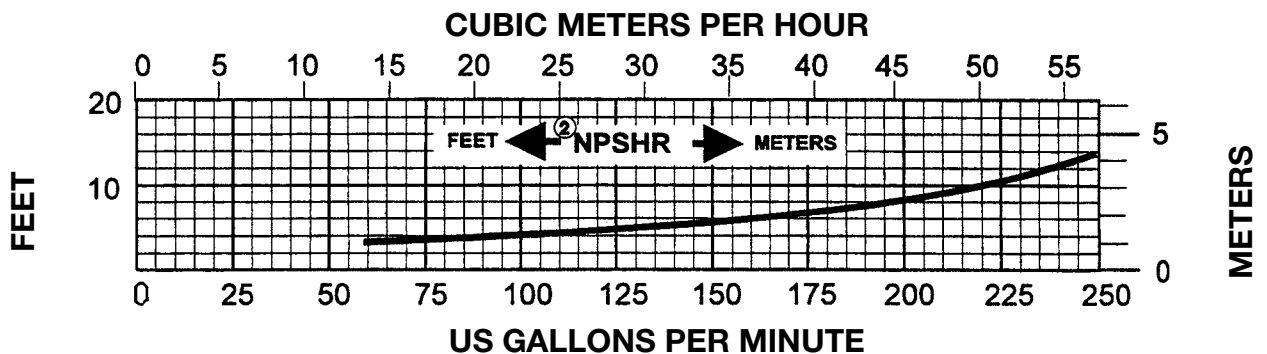
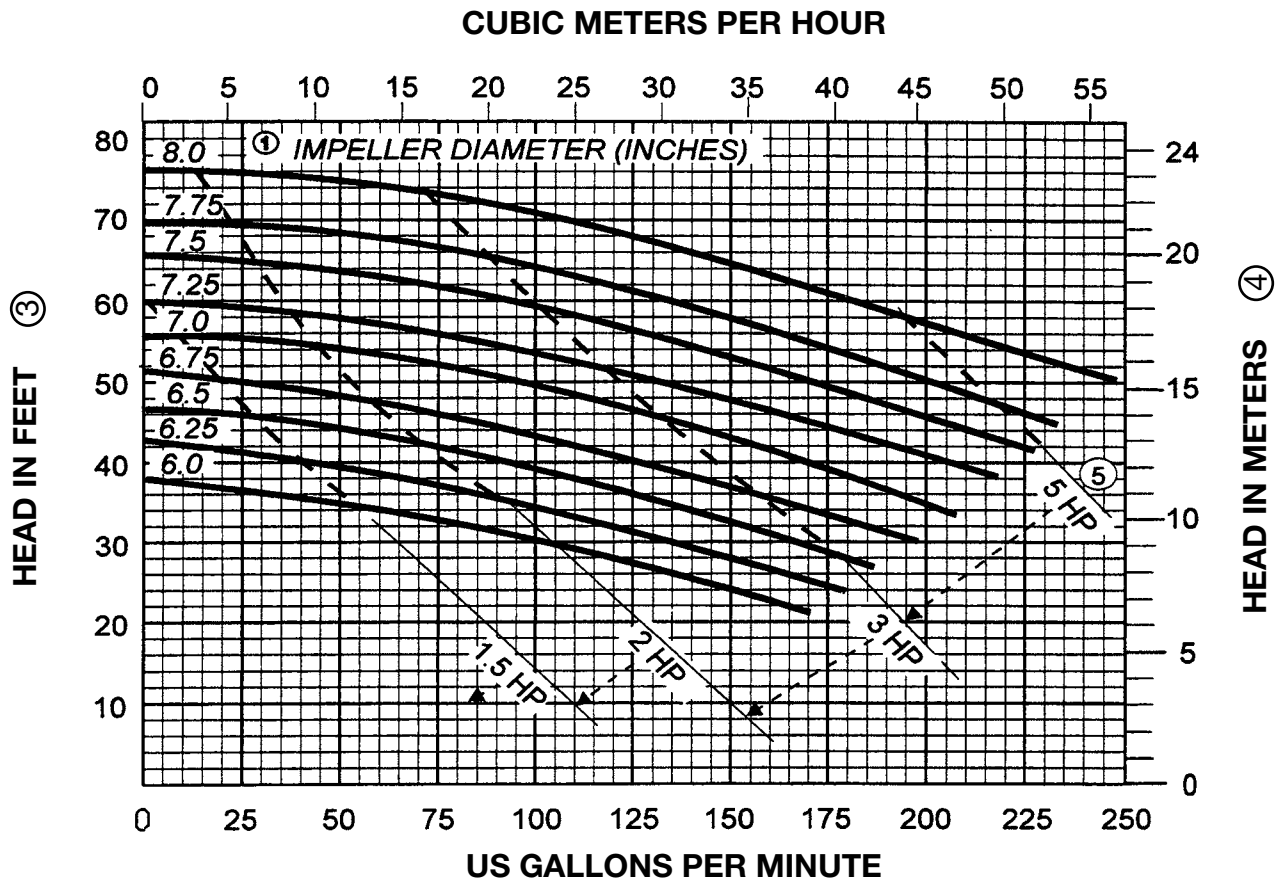

- NOTES:**
- ① Impeller diameters available in 1/16 inch increments
  - ② NPSHR is shown for maximum impeller diameter
  - ③  $PSI = \frac{\text{Head in Feet} \times \text{Specific Gravity}}{2.3}$
  - ④  $Kg/cm^2 = \frac{\text{Head in Meters} \times \text{Specific Gravity}}{10}$
  - ⑤  $HP \times 0.746 = Kw$

# TOP-FLO® TF-C Series Centrifugal Pumps

## Capacity Curves

Based on water at 70°F (22°C)

Model: TF-C328

60 Hz

1750 RPM

Size: 3 x 2 x 8

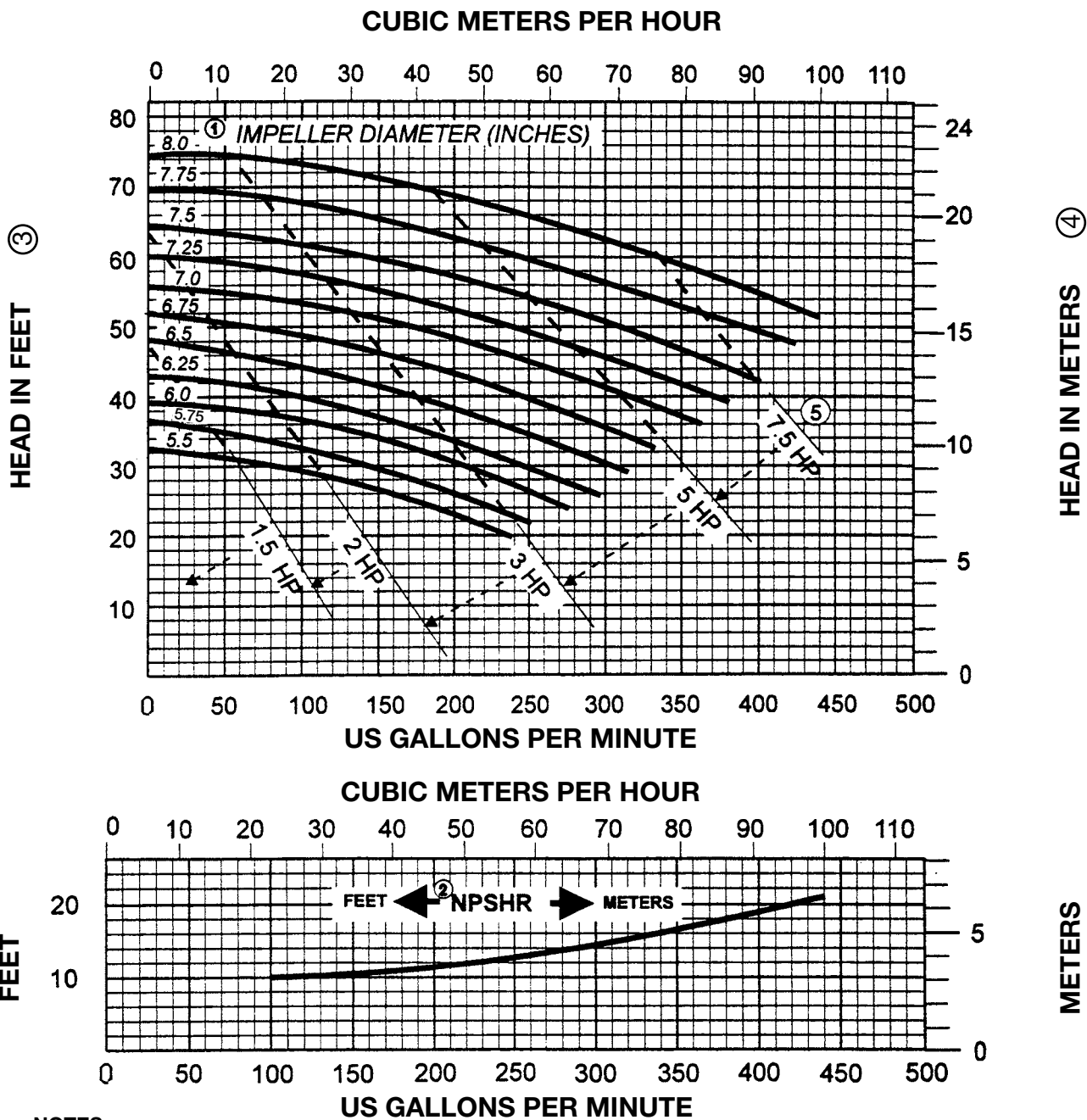

**NOTES:**

- ① Impeller diameters available in 1/4 inch increments
- ② NPSHR is shown for maximum impeller diameter
- ③  $PSI = \frac{\text{Head in Feet} \times \text{Specific Gravity}}{2.3}$
- ④  $Kg/cm^2 = \frac{\text{Head in Meters} \times \text{Specific Gravity}}{10}$
- ⑤  $HP \times 0.746 = Kw$

# TOP-FLO<sup>®</sup> TF-C Series Centrifugal Pumps

## Capacity Curves

Based on water at 70°F (22°C)

Model: TF-C328

60 Hz

1750 RPM

Size: 4 x 2 x 8

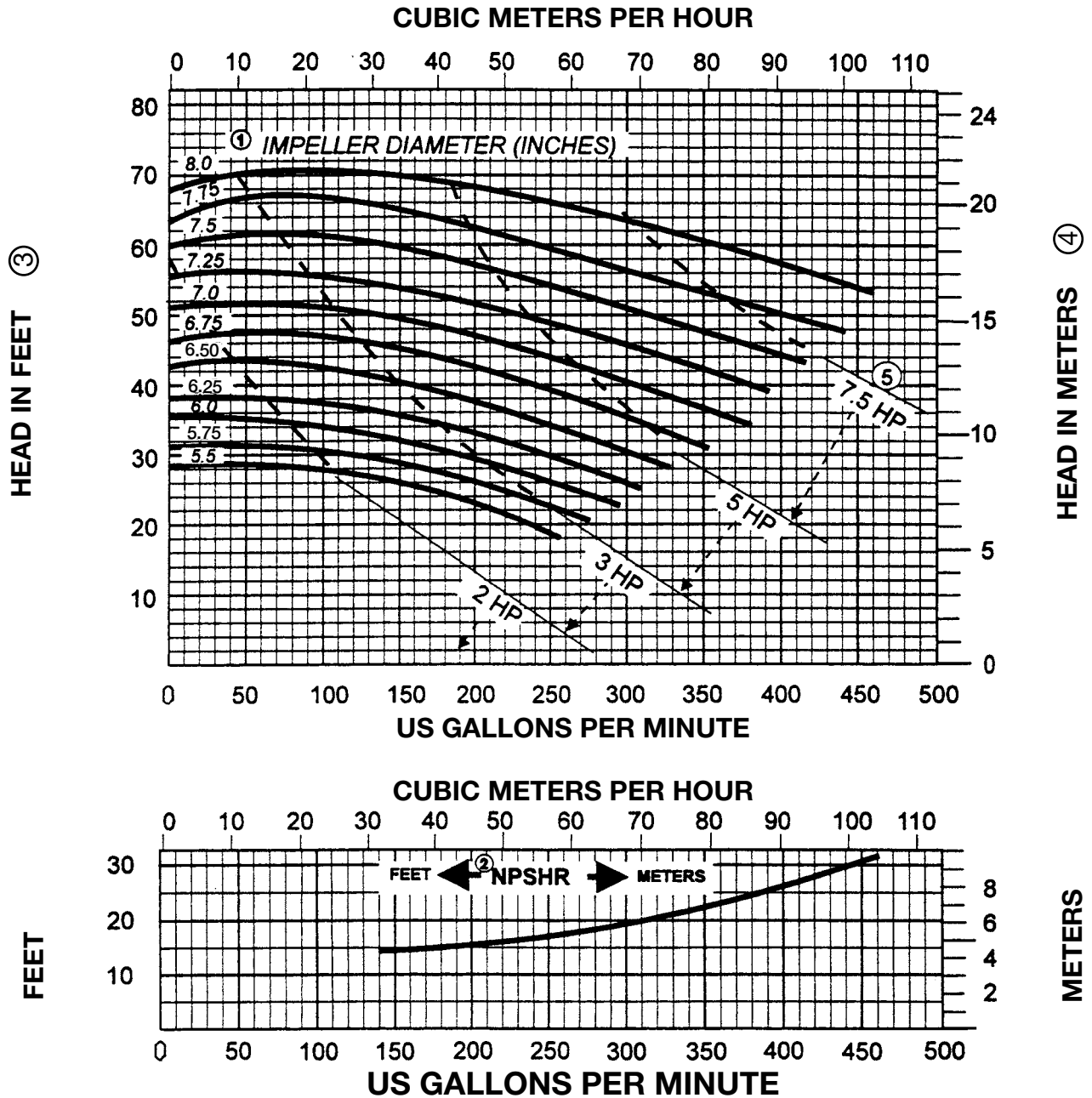

- NOTES:**
- (1) Impeller diameters available in 1/4 inch increments
  - (2) NPSHR is shown for maximum impeller diameter
  - (3)  $PSI = \frac{\text{Head in Feet} \times \text{Specific Gravity}}{2.3}$
  - (4)  $Kg/cm^2 = \frac{\text{Head in Meters} \times \text{Specific Gravity}}{10}$
  - (5)  $HP \times 0.746 = Kw$

# TOP-FLO® TF-C Series Centrifugal Pumps

## Capacity Curves

Based on water at 70°F (22°C)

Model: TF-C100

60 Hz

3500 RPM

Size: 1-1/2 x 1 x 3-11/16

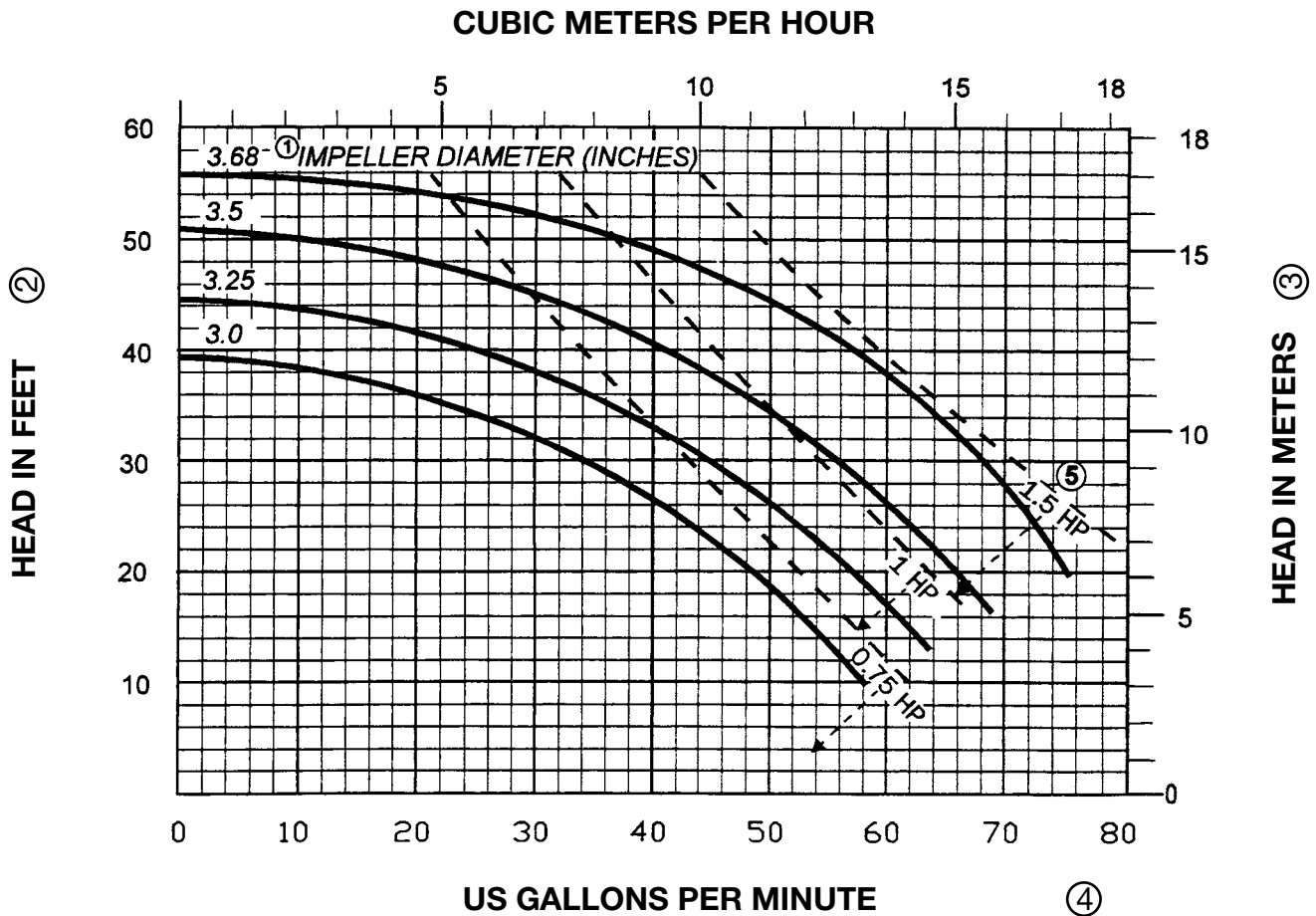

**NOTES:**

① Impeller diameters available in 1/16 inch increments

③  $\text{Kg/cm}^2 = \frac{\text{Head in Meters} \times \text{Specific Gravity}}{10}$

②  $\text{PSI} = \frac{\text{Head in Feet} \times \text{Specific Gravity}}{2.3}$

④  $\text{HP} \times 0.746 = \text{Kw}$

# TOP-FLO<sup>®</sup> TF-C Series Centrifugal Pumps

## Capacity Curves

Based on water at 70°F (22°C)

Model: TF-C114

60 Hz

3500 RPM

Size: 1-1/2 x 1-1/2 x 4

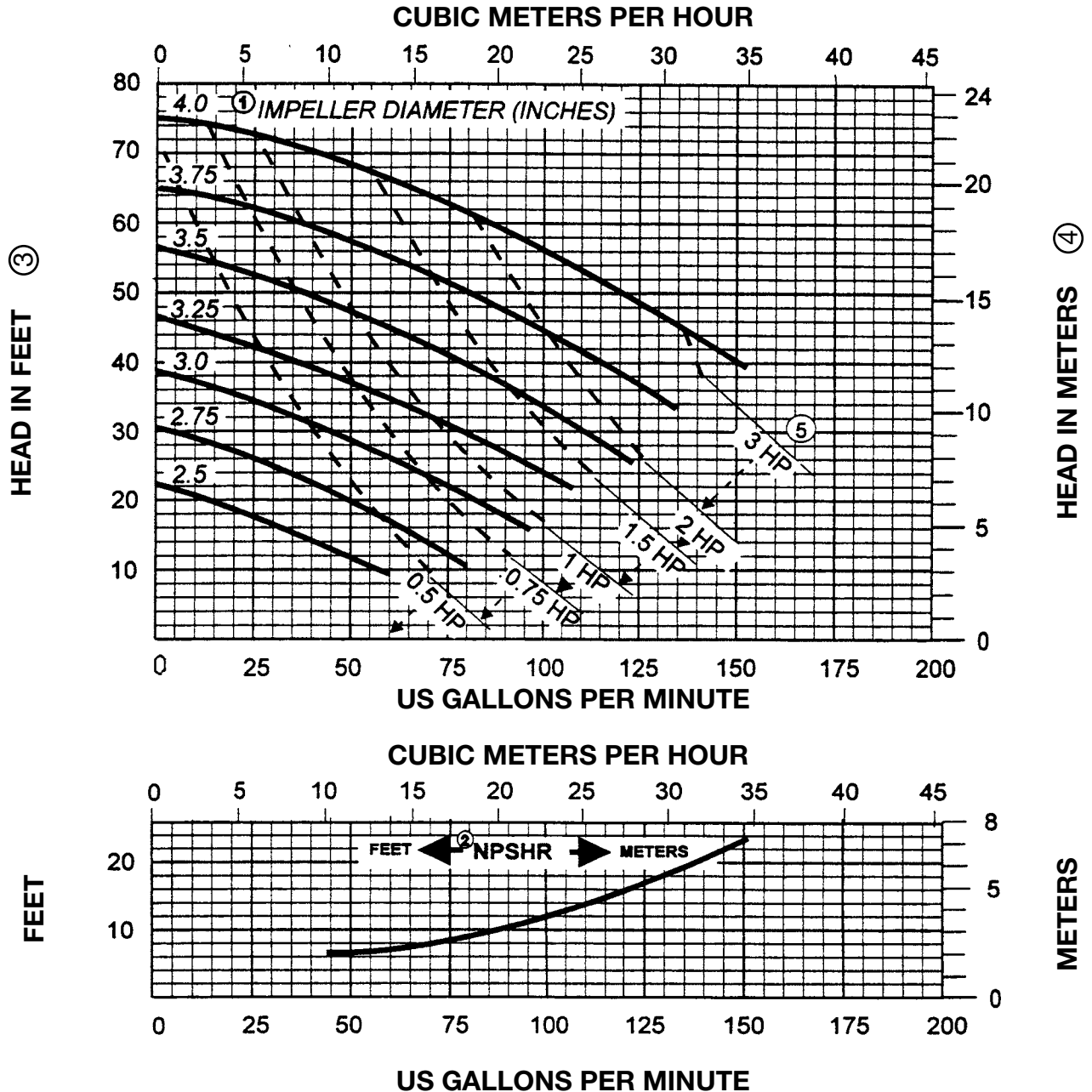

- NOTES:**
- (1) Impeller diameters available in 1/4 inch increments
  - (2) NPSHR is shown for maximum impeller diameter
  - (3)  $PSI = \frac{\text{Head in Feet} \times \text{Specific Gravity}}{2.3}$
  - (4)  $Kg/cm^2 = \frac{\text{Head in Meters} \times \text{Specific Gravity}}{10}$
  - (5)  $HP \times 0.746 = Kw$

# TOP-FLO<sup>®</sup> TF-C Series Centrifugal Pumps

## Capacity Curves

Based on water at 70°F (22°C)

Model: TF-C114

60 Hz

3500 RPM

Size: 2 x 1-1/2 x 4

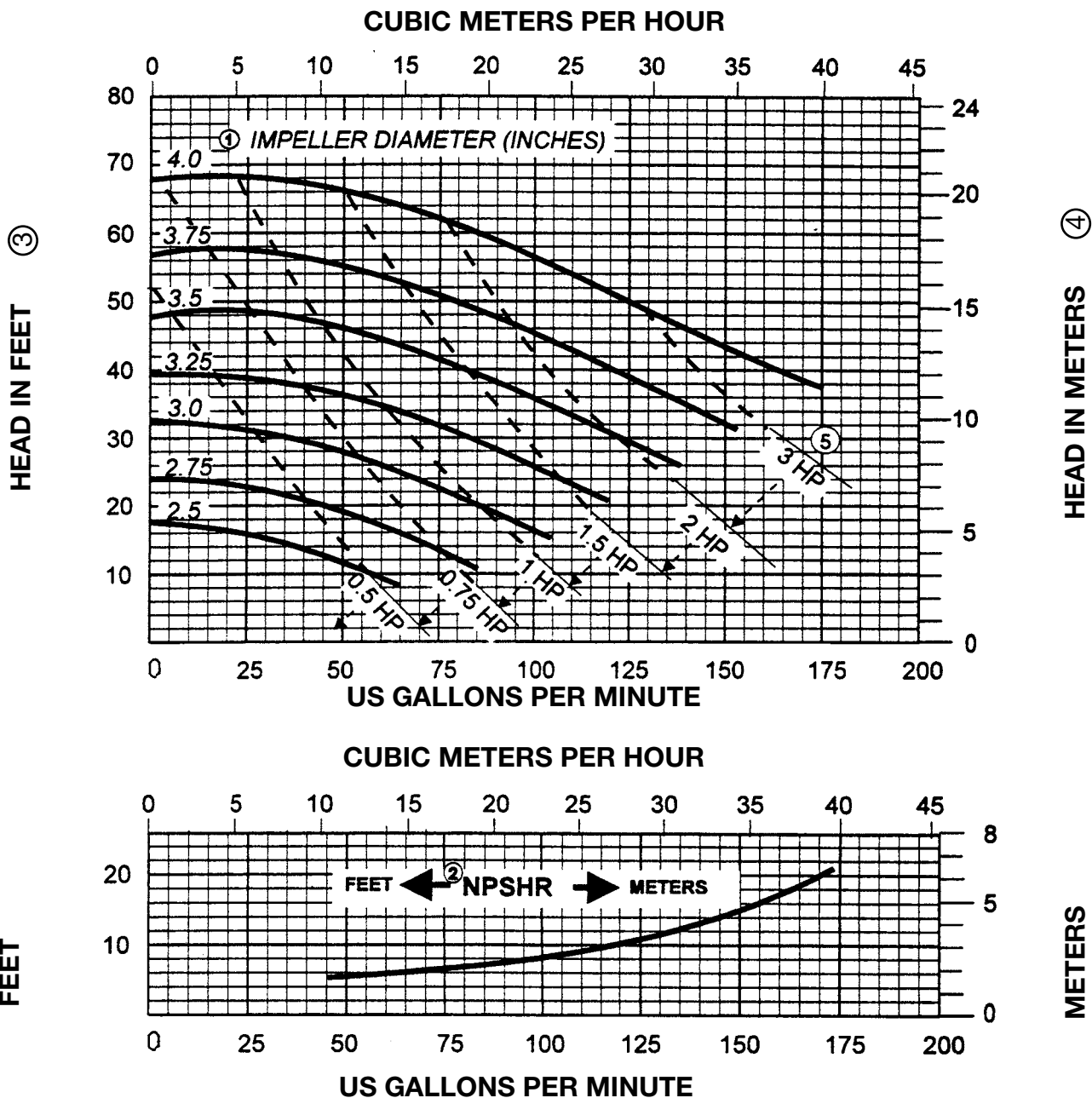

### NOTES:

- ① Impeller diameters available in 1/4 inch increments
- ② NPSHR is shown for maximum impeller diameter
- ③  $PSI = \frac{\text{Head in Feet} \times \text{Specific Gravity}}{2.3}$
- ④  $Kg/cm^2 = \frac{\text{Head in Meters} \times \text{Specific Gravity}}{10}$
- ⑤  $HP \times 0.746 = Kw$

# TOP-FLO<sup>®</sup> TF-C Series Centrifugal Pumps

## Capacity Curves

Based on water at 70°F (22°C)

Model: TF-C216

60 Hz

3500 RPM

Size: 2 x 1-1/2 x 6

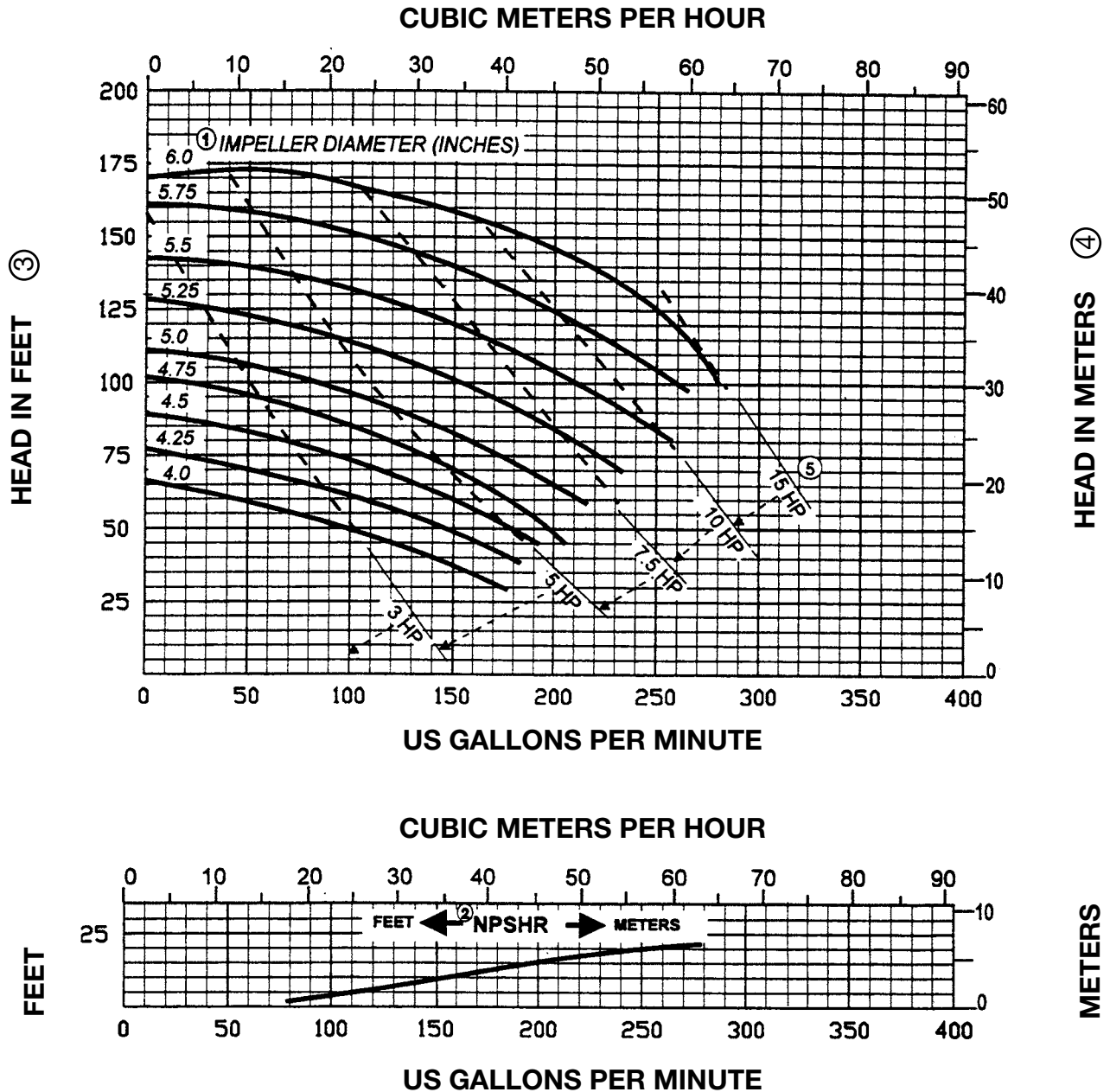

### NOTES:

① Impeller diameters available in 1/4 inch increments

② NPSHR is shown for maximum impeller diameter

③  $PSI = \frac{\text{Head in Feet} \times \text{Specific Gravity}}{2.3}$

④  $Kg/cm^2 = \frac{\text{Head in Meters} \times \text{Specific Gravity}}{10}$

⑤  $HP \times 0.746 = Kw$

# TOP-FLO<sup>®</sup> TF-C Series Centrifugal Pumps

## Capacity Curves

Based on water at 70°F (22°C)

Model: TF-C216

60 Hz

3500 RPM

Size: 2-1/2 x 1-1/2 x 6

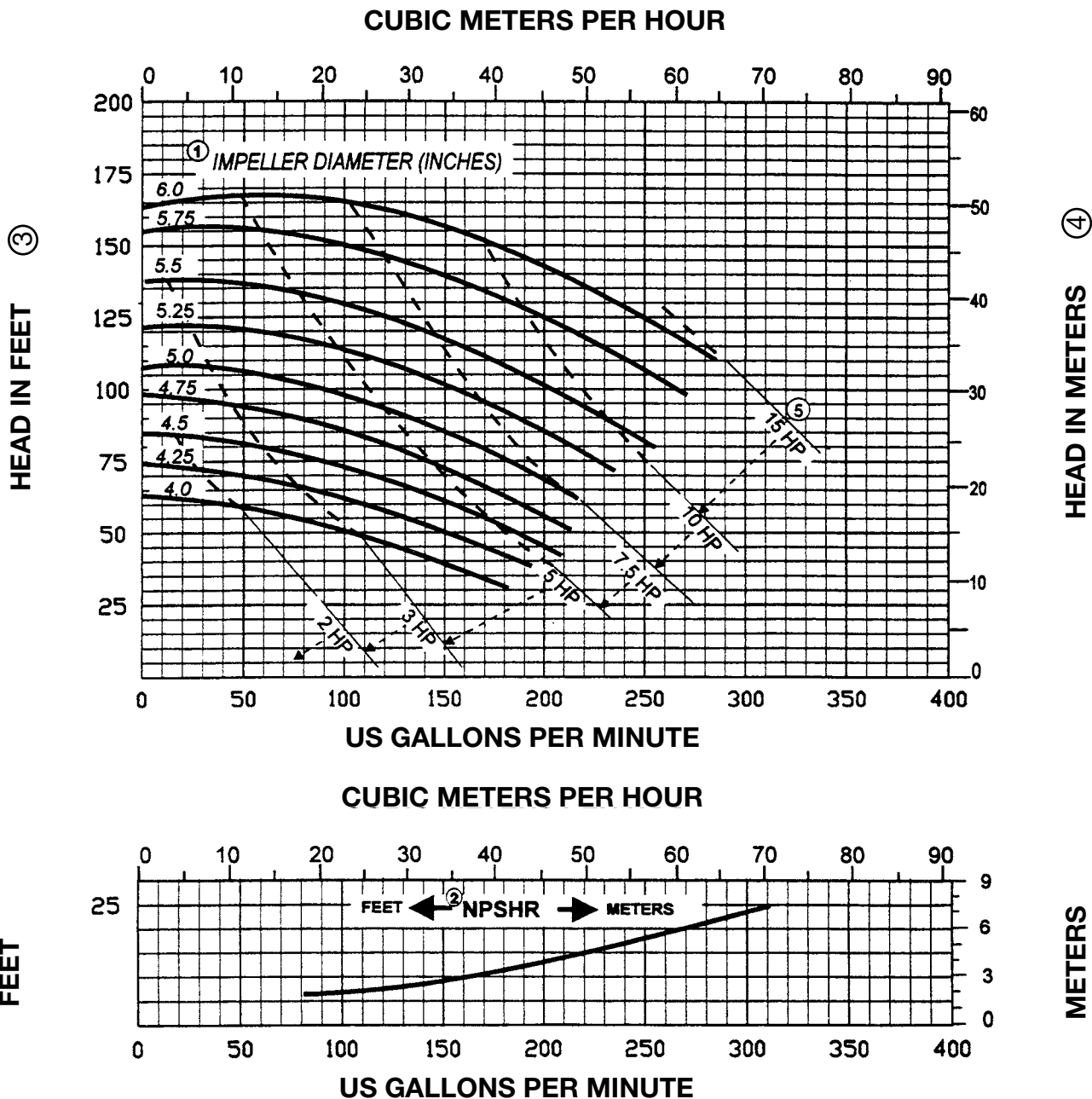

**NOTES:**

- ① Impeller diameters available in 1/4 inch increments
- ② NPSHR is shown for maximum impeller diameter
- ③  $PSI = \frac{\text{Head in Feet} \times \text{Specific Gravity}}{2.3}$
- ④  $Kg/cm^2 = \frac{\text{Head in Meters} \times \text{Specific Gravity}}{10}$
- ⑤  $HP \times 0.746 = Kw$

# TOP-FLO<sup>®</sup> TF-C Series Centrifugal Pumps

## Capacity Curves

Based on water at 70°F (22°C)

Model: TF-C218

60 Hz

3500 RPM

Size: 2 x 1-1/2 x 8

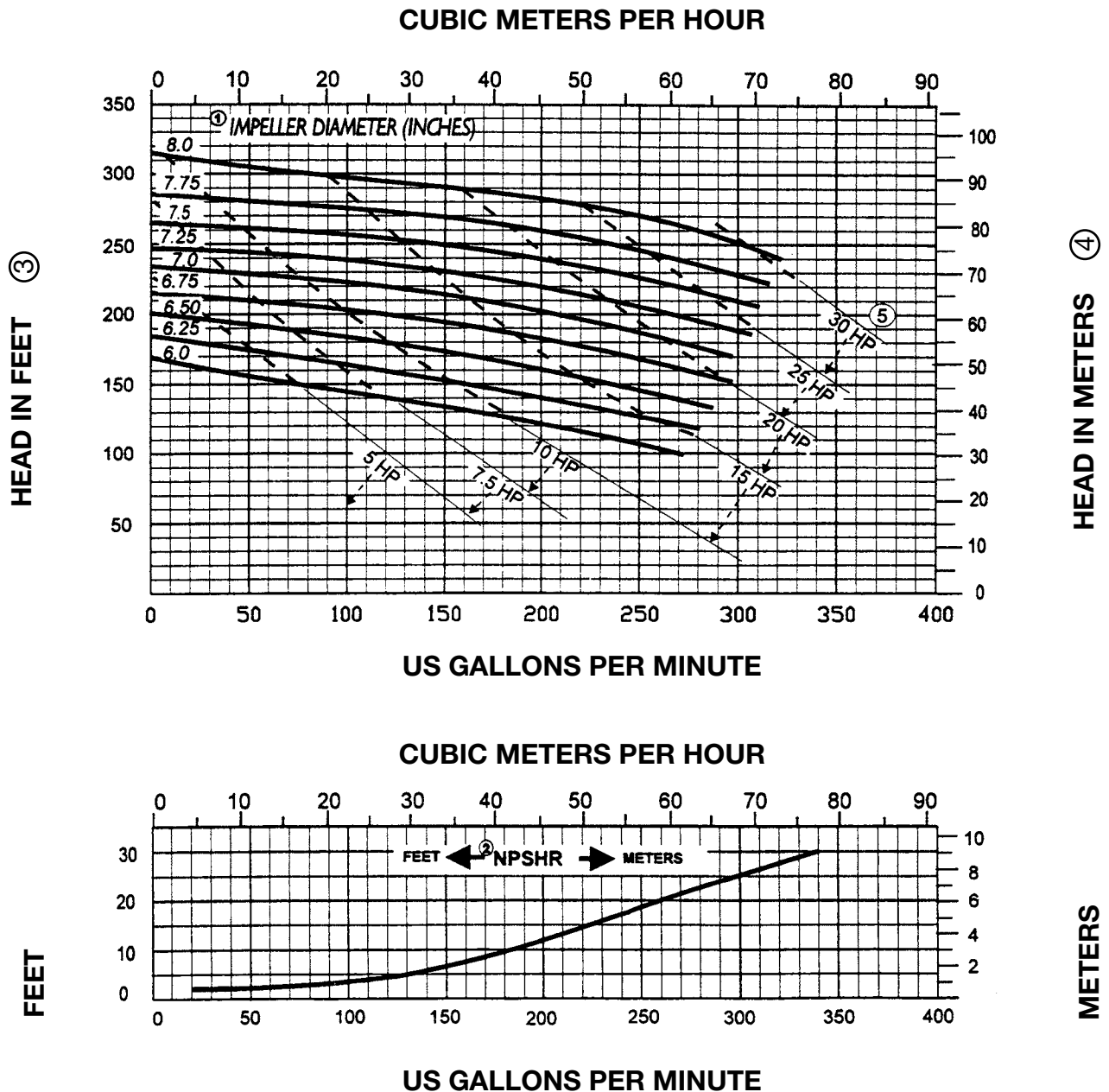

- NOTES:**
- (1) Impeller diameters available in 1/4 inch increments
  - (2) NPSHR is shown for maximum impeller diameter
  - (3)  $PSI = \frac{\text{Head in Feet} \times \text{Specific Gravity}}{2.3}$
  - (4)  $Kg/cm^2 = \frac{\text{Head in Meters} \times \text{Specific Gravity}}{10}$
  - (5)  $HP \times 0.746 = Kw$

# TOP-FLO® TF-C Series Centrifugal Pumps

## Capacity Curves

Based on water at 70°F (22°C)

Model: TF-C218

60 Hz

3500 RPM

Size: 3 x 1-1/2 x 8

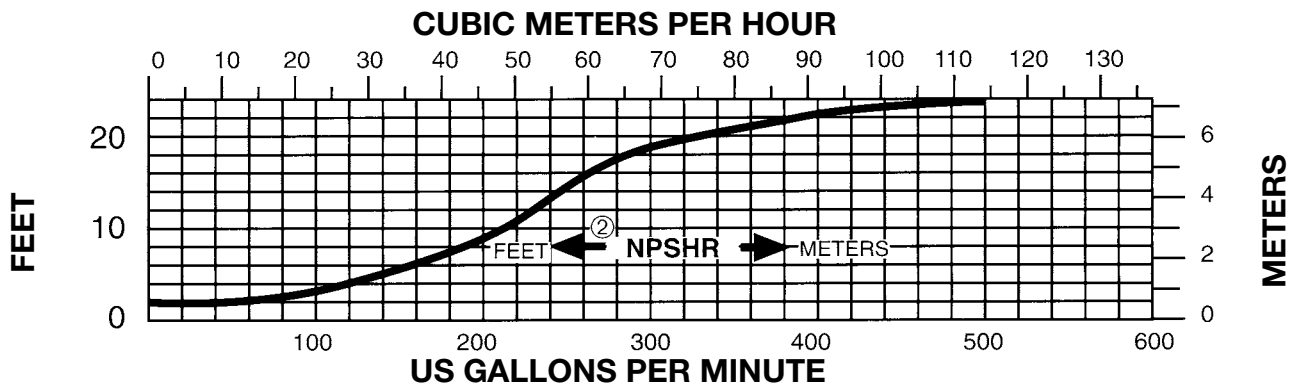
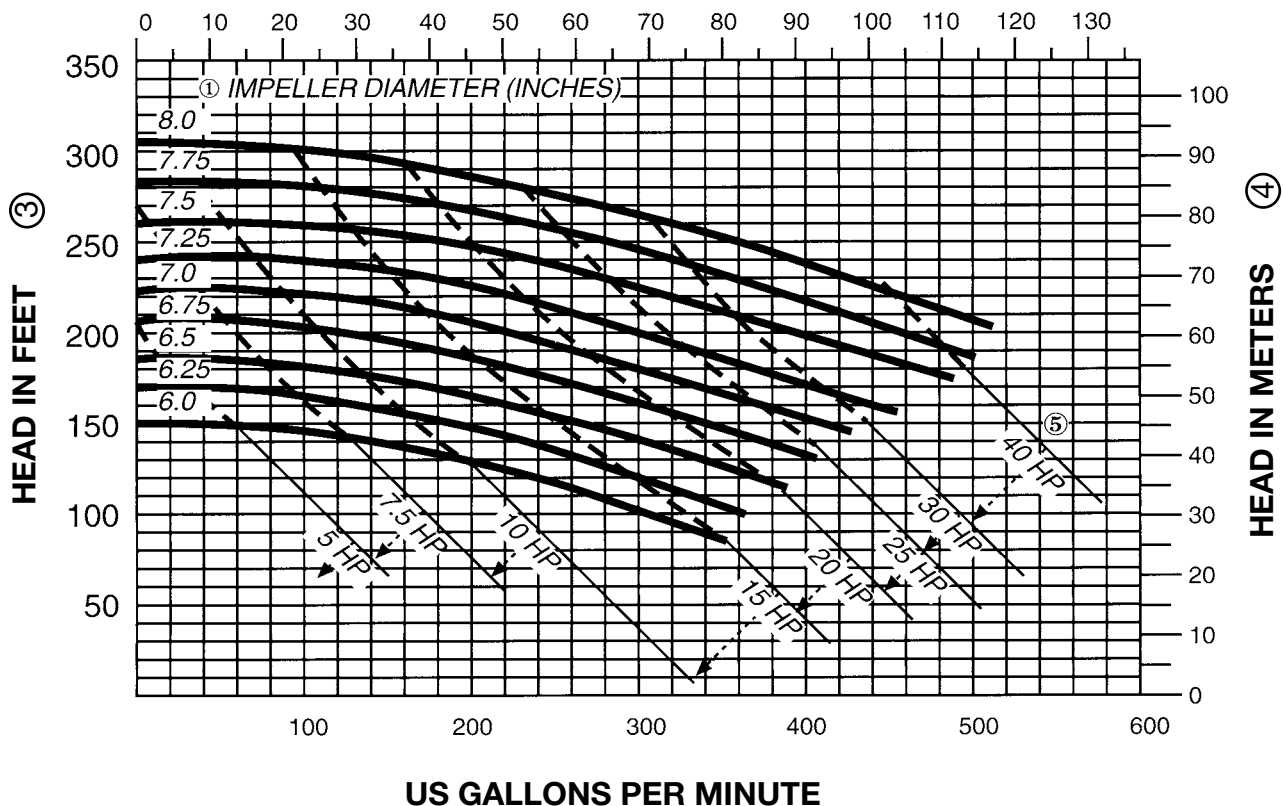

### NOTES:

- ① Impeller diameters available in 1/4 inch increments
- ② NPSHR is shown for maximum impeller diameter
- ③  $PSI = \frac{\text{Head in Feet} \times \text{Specific Gravity}}{2.3}$
- ④  $Kg/cm^2 = \frac{\text{Head in Meters} \times \text{Specific Gravity}}{10}$
- ⑤  $HP \times 0.746 = Kw$

# TOP-FLO<sup>®</sup> TF-C Series Centrifugal Pumps

## Capacity Curves

Based on water at 70°F (22°C)

Model: TF-C328

60 Hz

3500 RPM

Size: 3 x 2 x 8

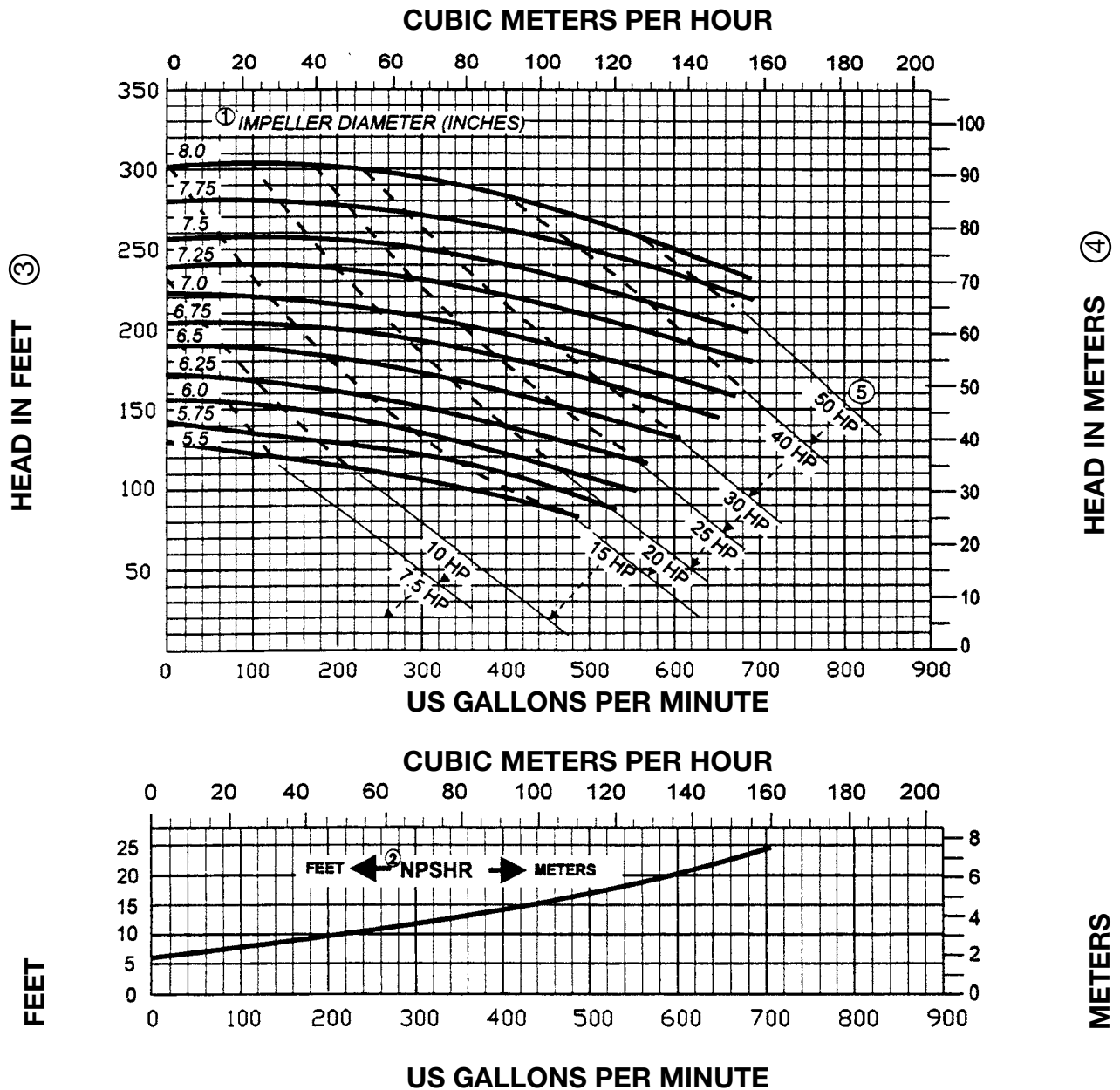

- NOTES:**
- ① Impeller diameters available in 1/4 inch increments
  - ② NPSHR is shown for maximum impeller diameter
  - ③  $PSI = \frac{\text{Head in Feet} \times \text{Specific Gravity}}{2.3}$
  - ④  $Kg/cm^2 = \frac{\text{Head in Meters} \times \text{Specific Gravity}}{10}$
  - ⑤  $HP \times 0.746 = Kw$

# TOP-FLO® TF-C Series Centrifugal Pumps

## Capacity Curves

Based on water at 70°F (22°C)

Model: TF-C328

60 Hz

3500 RPM

Size: 4 x 2 x 8

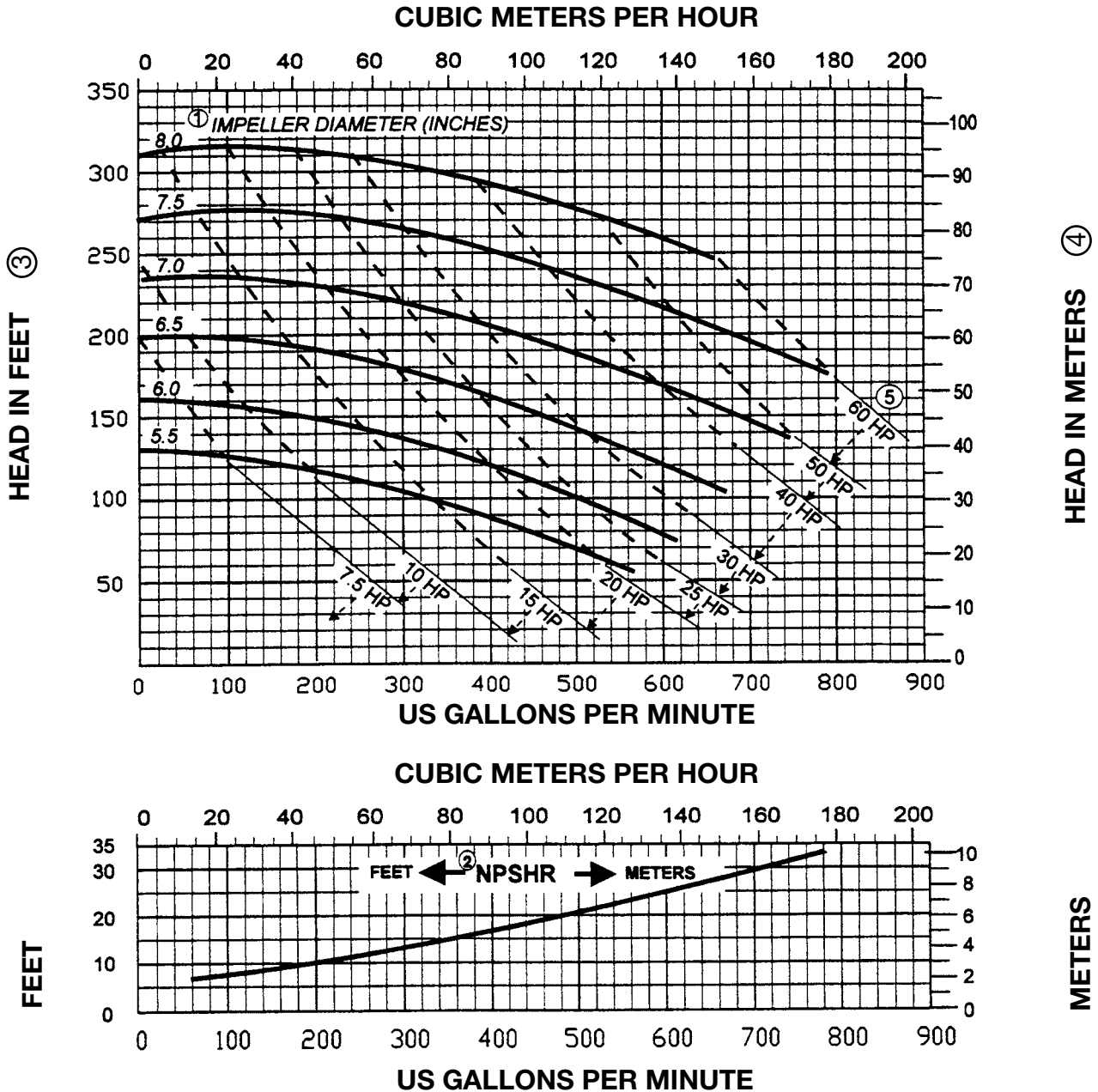

### NOTES:

① Impeller diameters available in 1/4 inch increments

④  $\text{Kg/cm}^2 = \frac{\text{Head in Meters} \times \text{Specific Gravity}}{10}$

② NPSHR is shown for maximum impeller diameter

⑤  $\text{HP} \times 0.746 = \text{Kw}$

③  $\text{PSI} = \frac{\text{Head in Feet} \times \text{Specific Gravity}}{2.3}$

# Viscosity and Specific Gravity Table for Various Products

Product	Specific Gravity	Viscosity
Acetic Acid		
5%	1.01	
10%	1.01	31.7 SSU @ 59°F
50%	1.06	33 SSU @ 59°F
80%	1.08	35 SSU @ 59°F
Animal Fat	0.9	130 SSU @ 115°F 50 SSU @ 200°F
Barbecue Sauce	1.05	11,500 SSU @ 40-75°F
Beer	1.02	32 SSU @ 68°F
Blood - Animal	.93-.98	15,000 SSU @ 55°F
Butter	.93-.98	15,000 SSU @ 55°F 440 SSU @ 90°F 220 SSU @ 115°F
Coconut Oil	0.92	125 SSU @ 106°F
Corn Oil	0.92	135 SSU @ 130°F 54 SSU @ 212°F
Corn Starch Solutions		
22 Baume	1.18	150 SSU @ 70°F 130 SSU @ 100°F
24 Baume	1.2	600 SSU @ 70°F 440 SSU @ 100°F
25 Baume	1.21	1400 SSU @ 70°F 800 SSU @ 100°F
Cottage Cheese	1.02	4,300 SSU
Dressing		
Cream (Sweet)	1	73 SSU
	.99	140 SSU
	.99	215 SSU
Egg Yolk	1.12	21,500 @ 35°F
Gelatin	1.01	1,380 - 2,580 SSU @ 160°F
Glucose	1.35 - 1.44	35M - 100M SSU @ 100°F 4M - 11M @ 150°F

Product	Specific Gravity	Viscosity
Honey	1.3	1250 - 1425 SSU @ 100°F
Ice Cream Mix	1.15	1050 SSU @ 46°F
Lard	0.96	287 @ 100°F
Linseed Oil	.92-.94	143 @ 100°F 93 @ 130°F
Malt Syrup	1.41	85,400 SSU @ 77°F
Maple Syrup	1.37	2,000 SSU @ 68°F
Margarine	0.93	13,900 SSU @ 84°F
Milk	1.02 - 1.05	31.5 @ 68°F
Molasses		
A. First	1.4 - 1.46	1300 - 23,500 SSU @ 100°F 700 - 8160 SSU @ 130°F
B. Second	1.43 - 1.48	6535 - 61,180 SSU @ 100°F 3058 - 15294 SSU @ 130°F
C. Blackstrap	1.46 - 1.49	12,190 - 255M @ 100°F
Mustard	1	17,000 SSU @ 85°F
Olive Oil	.91 - .92	200 SSU @ 100°F
Peanut Butter	1.2	77,400 SSU @ 110 - 140°F
Sesame Seed Oil	0.92	184 SSU @ 100°F 110 @ 130°F
Soy Bean Oil	0.91	500 SSU @ 44°F
Tomato Paste	1.14	60M - 80 M SSU 21M SSU approx.
Water	1	31 SSU @ 68°F

# How Capacity Affects Friction

The following table was developed to indicate loss of head due to friction – in feet loss per fitting or in feet loss per foot of tubing – through stainless steel tubing and sanitary fittings.

## Friction Loss in Sanitary OD Tubing and Fittings

Capacity in U.S. G.P.M.	O.D. Tube Size																	
	1 I.D.=.870			1-1/2 I.D.=1.370			2 I.D.=1.870			2-1/2 I.D.=2.370			3 I.D.=2.870			4 I.D.=3.834		
	Tubing	Elbow	Tee	Tubing	Elbow	Tee	Tubing	Elbow	Tee	Tubing	Elbow	Tee	Tubing	Elbow	Tee	Tubing	Elbow	Tee
2	.01	.01	.1															
4	.025	.02	.2															
5	.035	.025	.25															
10	.12	.06	.4	.02	.01	.15	.005	.015	.1									
15	.25	.1	.8	.04	.02	.25	.013	.02	.15									
20	.43	.22	1.5	.06	.03	.3	.02	.025	.2	.005	.02	.1	.003	.02	.06			
25	.66	.4	2.3	.08	.04	.4	.025	.03	.25	.006	.03	.15	.004	.03	.08			
30	.93	.7	3.3	.105	.06	.55	.035	.05	.3	.008	.05	.2	.005	.04	.1			
35	1.22	1.25	5.2	.135	.09	.8	.04	.06	.4	.011	.06	.25	.006	.05	.13			
40				.17	.11	1.0	.05	.08	.5	.015	.07	.3	.007	.06	.15			
45				.21	.16	1.3	.063	.1	.6	.02	.09	.35	.008	.065	.18			
50				.25	.2	1.6	.073	.12	.7	.022	.1	.4	.01	.07	.2			
60				.34	.35	2.2	.1	.18	.9	.03	.12	.45	.015	.08	.25			
80				.57	.76	3.7	.16	.3	1.5	.05	.15	.55	.02	.1	.4			
100				.85	1.35	5.8	.23	.44	2.3	.075	.18	.6	.03	.11	.5	.008	.04	.1
120				1.18	2.05	9.1	.32	.64	3.3	.105	.21	1.0	.04	.13	.6	.01	.05	.15
140							.42	.85	4.5	.14	.23	1.25	.05	.16	.8	.013	.06	.2
160							.54	1.13	5.8	.17	.28	1.6	.07	.2	1.1	.015	.07	.25
180							.67	1.45	7.4	.205	.31	2.0	.08	.21	1.3	.02	.08	.3
200							.81	1.82	9.0	.245	.35	2.5	.1	.26	1.6	.025	.09	.4
220							.95	2.22	11.0	.29	.41	3.0	.12	.3	1.9	.028	.1	.5
240							1.10	2.63	13.5	.34	.48	3.7	.14	.33	2.2	.035	.11	.55
260										.39	.53	4.5	.165	.39	2.5	.04	.115	.6
280										.45	.61	5.3	.19	.42	2.8	.045	.12	.65
300										.515	.7	6.2	.22	.5	3.1	.05	.13	.7
350										.68	1.05	8.5	.28	.67	4.1	.07	.15	.9
400										.86	1.55	11.0	.36	.88	5.2	.085	.18	1.2
450										1.05	2.25	13.5	.44	1.1	6.6	.105	.2	1.5
500													.54	1.4	8.0	.13	.23	1.75
550													.64	1.7	9.5	.15	.27	2.1
600													.75	2.05	10.2	.175	.3	2.5
650													.87	2.41	13.0	.2	.34	2.8
700													1.0	2.8	15.0	.23	.4	3.4
750																.26	.43	3.8
800																.3	.5	4.4
850																.33	.56	5.
900																.37	.62	5.7
950																.41	.7	6.3
1000																.45	.8	7.0
1100																.53	1.06	8.6

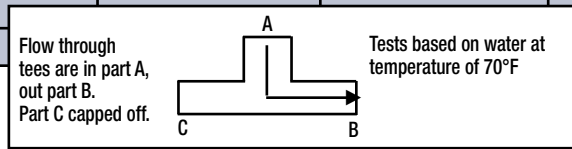

Source: National Association of Food and Dairy Equipment Manufacturers.

# TOP-FLO® TF-C Series Close-Coupled Pump Dimensions

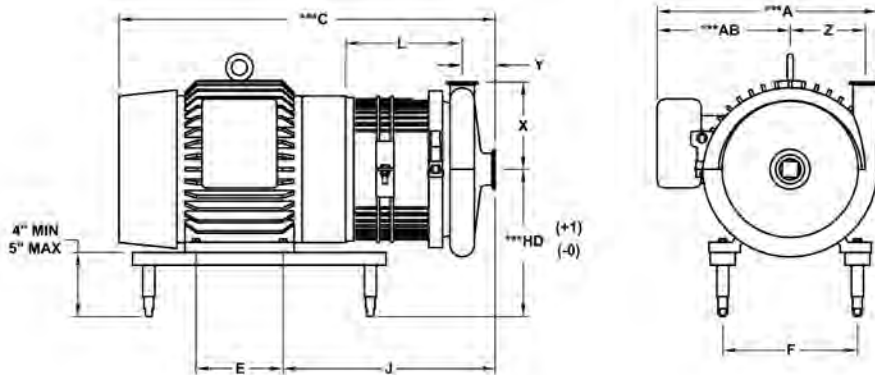

## PUMP DIMENSIONS

PUMP MODEL	SUCTION	DISCHARGE	*X	*Y	**X	**Y	Z
TF-C100	1.500	1.000	3.500	1.554			1.453
TF-C114	1.500	1.500	3.625	1.594	3.875	1.844	2.625
TF-C216	2.000	1.500	4.500	1.906	4.750	2.156	3.688
TF-C218	2.000	1.500	5.500	1.719	5.750	1.969	4.750
TF-C328	3.000	2.000	5.500	2.219	5.750	2.719	4.750

## PUMP AND MOTOR DIMENSIONS WITH "WASHDOWN" TOTALLY ENCLOSED BALDOR MOTORS

PUMP MODEL	FRAME	A	*C	**C	HD	AB	*J	E	F	L
TF-C100	56C	8.313	13.312		7.500	5.000	6.875	3.000	4.875	2.750
TF-C114	56C	8.313	16.821	17.071	7.500	5.000	10.375	3.000	4.875	6.219
	143 TC	8.563	17.813	18.063	7.500	5.250	10.844	4.000	5.500	6.219
	145 TC	8.563	19.848	18.063	7.500	5.250	10.688	5.000	5.500	6.219
	182 TC	9.813	20.938	21.180	8.500	5.875	12.219	4.500	7.500	6.781
	184 TC	9.813	23.790	24.915	8.500	5.875	12.000	5.500	7.500	6.781
TF-C216	56C	8.313	16.976	17.226	7.500	5.000	10.531	3.000	4.875	6.062
	143 TC	8.563	17.968	18.223	7.500	5.250	10.844	4.000	5.500	6.062
	145 TC	8.563	20.003	20.253	7.500	5.250	10.844	5.000	5.500	6.062
	182 TC	9.813	21.157	21.399	8.500	5.875	12.219	4.500	7.500	6.688
	184 TC	9.813	24.009	24.259	8.500	5.875	12.219	5.500	7.500	6.688
	213 TC	12.156	26.487	26.624	9.250	7.375	13.969	5.500	8.500	7.813
	215 TC	12.156	27.864	28.114	9.250	7.375	13.969	7.000	8.500	7.813
	254 TC	16.094	28.533	28.783	10.250	9.625	14.594	8.250	10.000	8.437
	256 TC	16.094	30.163	30.413	10.250	9.625	14.594	10.000	10.000	8.437
TF-C218	143 TC	8.563	18.036	18.281	7.500	5.250	10.281	4.000	5.500	6.312
	145 TC	8.563	20.066	18.286	7.500	5.250	10.281	5.000	5.500	6.312
	182 TC	9.813	21.211	20.941	8.500	5.875	12.281	4.500	7.500	6.938
	184 TC	9.813	24.071	24.321	8.500	5.875	12.281	5.500	7.500	6.938
	213 TC	12.156	25.686	25.936	9.250	7.375	13.281	5.500	8.500	7.312
	215 TC	12.156	27.176	27.426	9.250	7.375	13.281	7.000	8.500	7.312
	254 TC	16.094	28.096	28.346	10.250	9.625	14.157	8.250	10.000	8.188
	256 TC	16.094	29.726	29.977	10.250	9.625	14.157	10.000	10.000	8.188
	284 TC	20.438	33.916	34.166	11.000	13.125	15.281	9.500	11.000	8.812
	286 TC	20.438	33.916	34.166	11.000	13.125	15.281	11.000	11.000	8.812
TF-C328	182 TC	9.813	22.024	22.524	8.500	5.875	13.094	4.500	7.500	7.250
	184 TC	9.813	24.884	25.384	8.500	5.875	13.094	5.500	7.500	7.250
	213 TC	12.156	26.499	26.999	9.250	7.375	14.094	5.500	8.500	7.625
	215 TC	12.156	29.664	28.489	9.250	7.375	14.094	7.000	8.500	7.625
	254 TC	16.094	28.909	29.409	10.250	9.625	15.000	8.250	10.000	8.500
	256 TC	16.094	30.539	31.039	10.250	9.625	15.000	10.000	10.000	8.500
	284 TC	20.438	34.729	35.229	11.000	13.125	16.094	9.500	11.000	9.125
	286 TC	20.438	34.729	35.229	11.000	13.125	16.094	11.000	11.000	9.125
	324 TC	22.375	37.311	37.811	12.000	14.125	17.156	10.500	12.500	9.812
	326 TC	22.375	37.311	37.811	12.000	14.125	17.156	12.000	12.500	9.812

\* WITH CLAMP CONNECTIONS (STANDARD)

\*\* WITH THREADED BEVEL SEAT CONNECTIONS

\*\*\* DIMENSIONS ARE FOR BALDOR WASHDOWN MOTORS

OTHER MOTOR MANUFACTURERS DIMENSIONS MAY VARY

FLANGE MOTORS

### NOTES:

ALL DIMENSIONS IN INCHES

DIMENSIONS ARE APPROXIMATE AND FOR GUIDANCE ONLY

THESE DIMENSIONS ARE FOR PUMPS USING NEMA STANDARD "C" FACE MOTORS

# TOP-FLO® Pump Replacement Kits

From time to time, centrifugal pump sealing components need to be replaced. TOP-FLO® centrifugal pump replacement part kits are specifically designed to fit in the pumps of not only TOP-FLO® pumps but those of major pump suppliers. These components are rugged and will provide the necessary sealing conditions under a wide range of conditions.

In addition to the pump replacement kits, Steel O'Brien offers a complete line of replacement parts. From impellers to leg brackets, Steel O'Brien should be your first choice for replacement parts.

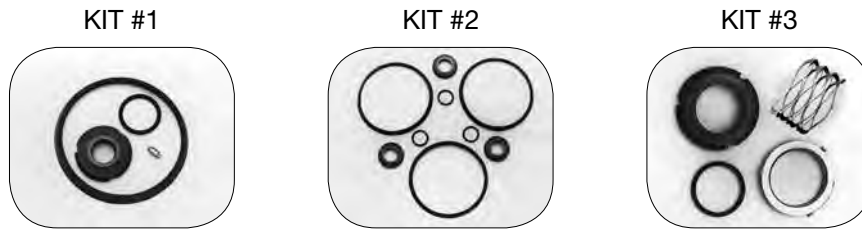

## “D” SEAL KITS

### TF-C100

	BUNA	FKM
Kit #1	5629K-1	5629V-1
Kit #2	5629K-2	5629V-2
Kit #3	5629K-3	5629V-3

### TF-C114

	BUNA	FKM
Kit #1	5649K-1	5649V-1
Kit #2	5649K-2	5649V-2
Kit #3	5649K-3	5649V-3

### TF-C216

	BUNA	FKM
Kit #1	5669K-1	5669V-1
Kit #2	5669K-2	5669V-2
Kit #3	5669K-3	5669V-3

### TF-C218/C328

	BUNA	FKM
Kit #1	5689K-1	5689V-1
Kit #2	5689K-2	5689V-2
Kit #3	5689K-3	5689V-3

**Kit #1** (Consists of 1 - Carbon Seal, 1 - Casing Gasket, 1 - O-Ring, and 1 - Retaining Pin)

**Kit #2** (Consists of 3 - Carbon Seals, 3 - Casing Gaskets, and 3 - O-Rings)

**Kit #3** (Consists of 1 - Carbon Seal, 1 - Spring, 1 - Cup, and 1 - O-Ring)

## “DG” SEAL KITS

### TF-C114 KIT

5649K-1DG			
CONSISTS OF:	KEY #	QTY.	DESCRIPTION
564980	80	1	Carbon Seal, Rotating
564924	24	1	Impeller Retainer Pin
564980N-SC	80N	1	Stationary Seat, Silicone Carbide
564980P	80P	1	PTFE Gasket, Outboard
564980R	80R	1	PTFE Gasket, Inboard
564980V	80V	1	Seal, O-Ring FKM
564990V	90V	1	Casing Gasket, FKM

### TF-C216 KIT

5669K-1DG			
CONSISTS OF:	KEY #	QTY.	DESCRIPTION
566980	80	1	Carbon Seal, Rotating
566924	24	1	Impeller Retainer Pin
566980N-SC	80N	1	Stationary Seat, Silicone Carbide
566980P	80P	1	PTFE Gasket, Outboard
566980R	80R	1	PTFE Gasket, Inboard
566980V	80V	1	Seal, O-Ring FKM
566990V	90V	1	Casing Gasket, FKM

### TF-C218/328 KIT

5689K-1DG			
CONSISTS OF:	KEY #	QTY.	DESCRIPTION
568980	80	1	Carbon Seal, Rotating
568924	24	1	Impeller Retainer Pin
568980N-SC	80N	1	Stationary Seat, Silicone Carbide
568980P	80P	1	PTFE Gasket, Outboard
568980R	80R	1	PTFE Gasket, Inboard
568980V	80V	1	Seal, O-Ring FKM
568990V	90V	1	Casing Gasket, FKM

## “E” SEAL KITS

### TF-C114 KIT

5649EK-1			
CONSISTS OF:	KEY #	QTY.	DESCRIPTION
564980	80	2	Carbon Seal
564980V	80V	2	Seal O-Ring FKM
564980G	80G	2	Cup (E Seal)
564917B	17B	1	O-Ring FKM
566917B	83E	1	O-Ring FKM
564980H	80H	1	Spring (E Seal)
564990V	90V	1	Casing Gasket FKM

### TF-C216 KIT

5669EK-1			
CONSISTS OF:	KEY #	QTY.	DESCRIPTION
566980	80	2	Carbon Seal
566980V	80V	2	Seal O-Ring FKM
566980G	80G	2	Cup (E Seal)
566917B	17B	1	O-Ring FKM
566983E	83E	1	O-Ring FKM
566980H	80H	1	Spring (E Seal)
566990V	90V	1	Casing Gasket FKM

### TF-C218/328 KIT

5689EK-1			
CONSISTS OF:	KEY #	QTY.	DESCRIPTION
568980	80	2	Carbon Seal
568980V	80V	2	Seal O-Ring FKM
568980G	80G	2	Cup (E Seal)
568917B	17B	1	O-Ring FKM
562990V	83E	1	O-Ring FKM
568980H	80H	1	Spring (E Seal)
568990V	90V	1	Casing Gasket FKM

# TOP-FLO® Pump Cart/Dolly

The mobility of the **TOP-FLO®** Pump Dolly allows you to find many uses in your manufacturing facility.



## SPECIFICATIONS:

- 304 SS metal components
- Bead blast finish
- Dimension 29"H x 12"W x 40.5" high
- (2) 8.0"D x 2.25"W ACM-TUFF wheels
- Right side mount cord bracket

## OPTIONAL FEATURES:

- Finishes: mechanical polish, electropolish
- Full range of control options: VFD, start/stop controls, network controls
- Wheels: non-marking white wheels, full pneumatic, solid
- Special customer design requirements

\* Wiring upgrade available\*\* Detailed drawings available upon request\*\* Pumps, motors, VFD, and switches sold separately.

## TOP-FLO® PUMP DOLLY CONFIGURATIONS



**DOLLY 1**  
(CUSTOMER MOUNTS MOTOR)

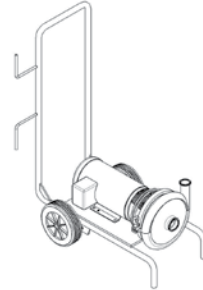

**DOLLY 2**  
(SUPPLIED WITH MOTOR MOUNTED)

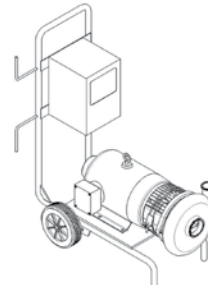

**DOLLY 3**  
(SUPPLIED WITH MOTOR & VFD MOUNTED)

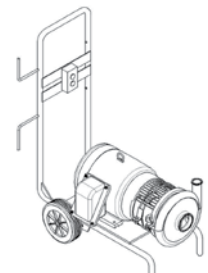

**DOLLY 4**  
(SUPPLIED WITH MOTOR & START/STOP MOUNTED)



**DOLLY 5**  
(SUPPLIED BARS FOR CUSTOMERS TO MOUNT MOTOR AND SWITCHES OR VFD)

# TOP-FLO<sup>®</sup> TL60ARV Air Relief Valve



The TL60ARV Air Relief Valve is used primarily when removal of air from a line without loss of product is a concern. The design of the TL60ARV is simple: a ferrule, a housing with a plastic ball, and a vent pipe all connected using 2 standard heavy duty clamps. This design will not let air enter the line or container under negative pressure.

The TL60ARV is double seated. The lightweight ball is freely moving and depending on pressure conditions will close against upper or lower seat. This valve is not designed for use in operation with liquids having less than 1.0 specific gravity.

The valve can be mounted on the top of a pipeline or container to bleed a pipeline where an air pocket may have formed during operation.

Bleeding a pipe on the suction side of a pump will be automatic. Air binding will be prevented. These valves are found mounted on the top of the inlet pipe in front of the pump.

**TL60ARV Air Relief Valve 1-1/2**

Description	Part Number	Qty.
1-1/2 TL60ARV	386015ARV	
Vent Top	38601525VT	1
Body	38601525	1
Base - 1-1/2	386015	1
Clamp	3299915	2
Gasket (FKM)	321010V	2
Ball 1.25	38601525B	1

**TL60ARV Air Relief Valve 2**

Description	Part Number	Qty.
2 TL60ARV	386020ARV	
Vent Top	38601525VT	1
Body	38601525	1
Base - 2	386020	1
Clamp	3299915	2
Gasket (FKM)	321010V	2
Ball 1.25	38601525B	1

**TL60ARV Air Relief Valve 2-1/2**

Description	Part Number	Qty.
2-1/2 TL60ARV	386025ARV	
Vent Top	38601525VT	1
Body	38601525	1
Base - 2-1/2	386025	1
Clamp	3299915	2
Gasket (FKM)	321010V	2
Ball 1.25	38601525B	1

**Ordering Information**

Steel grade .....Stainless steel, AISI 316L  
 Ball.....Polypropylene  
 Finish .....Polished to 32Ra

**Technical Data**

Maximum product pressure ..... 150 PSI  
 Maximum temperature .....275°F  
 Net weight ..... 19 oz. (9.5 kg)  
 For proper operation:  
 • Product density must be 1.0 or higher  
 • The valve must be mounted vertically

