

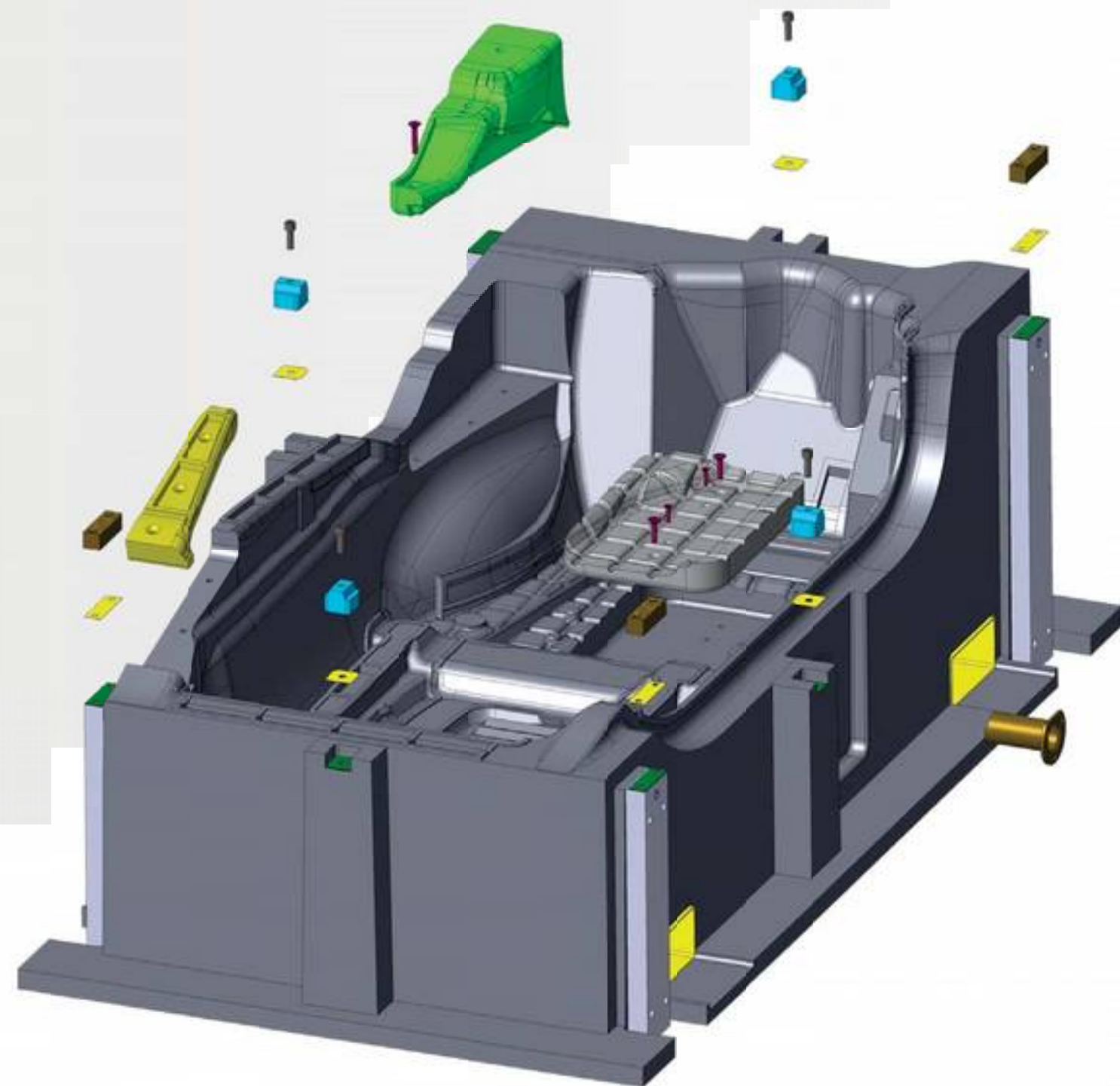

The shape of things to come

Self Group is a prime partner for the plastic processing industries and experts in Europe, North America and Far East markets. We can offer you unique and tailor-made solutions in design and manufacturing of large aluminium molds and tools.

Our intensive expertise includes the integrated product development and prototyping, tool engineering and manufacturing, service and process optimization.



OUR RANGE OF PRODUCTS COMPRISES A WIDE VARIETY OF TOOLS FOR PROTOTYPING & PRODUCTION

Molds for

- Vacuum & pressure forming
- Twin sheet forming
- Compression moulding
- Laminating
- RIM
- Foaming & Back foaming
- Combi / special processes

Gauges & Fixtures for

- Cooling
- Trimming
- Water jet cutting
- Joining /Assembly
- Checking
- Handling

Our Numbers

50+

Years of experience
Eng. & Mfg.

500+

Tools delivered
every year

95%

Recurring
customers

35

Countries

10.000+

Tools Worldwide

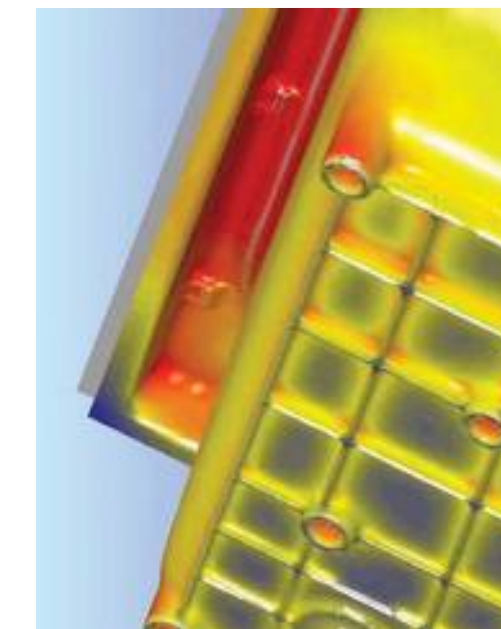

One Partner

We support you in every step

Our relationship starts with concept discussions, through co-design, to tools commissioning which includes mould try outs and after sales service.

We distinguish ourselves by our outstanding competence in engineering and project management and advanced production systems.

1 Product Co-engineering & Prototyping

2 Tools Engineering & Manufacturing

3 Life time support service

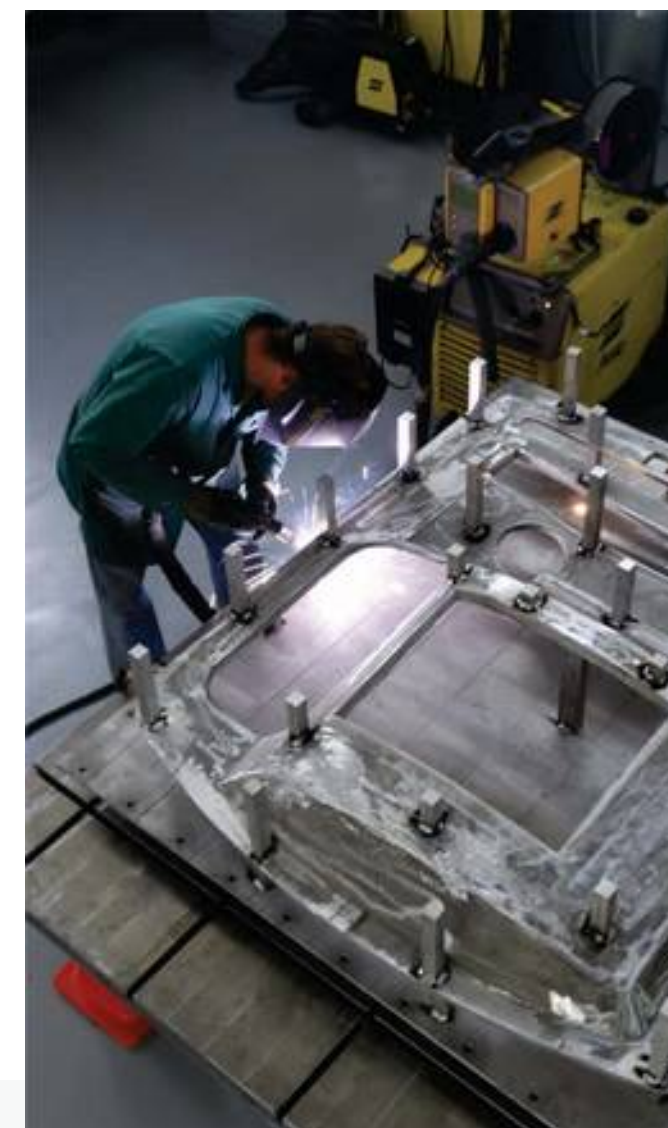

Our 50 years of expertise is at your disposal to insure your satisfaction and success!

Sectors & Applications

Self Group has a specific expertise and strong track record in different industries and products

We specialize in customer-specific and special individual solutions based on our broad range of tried and tested applications





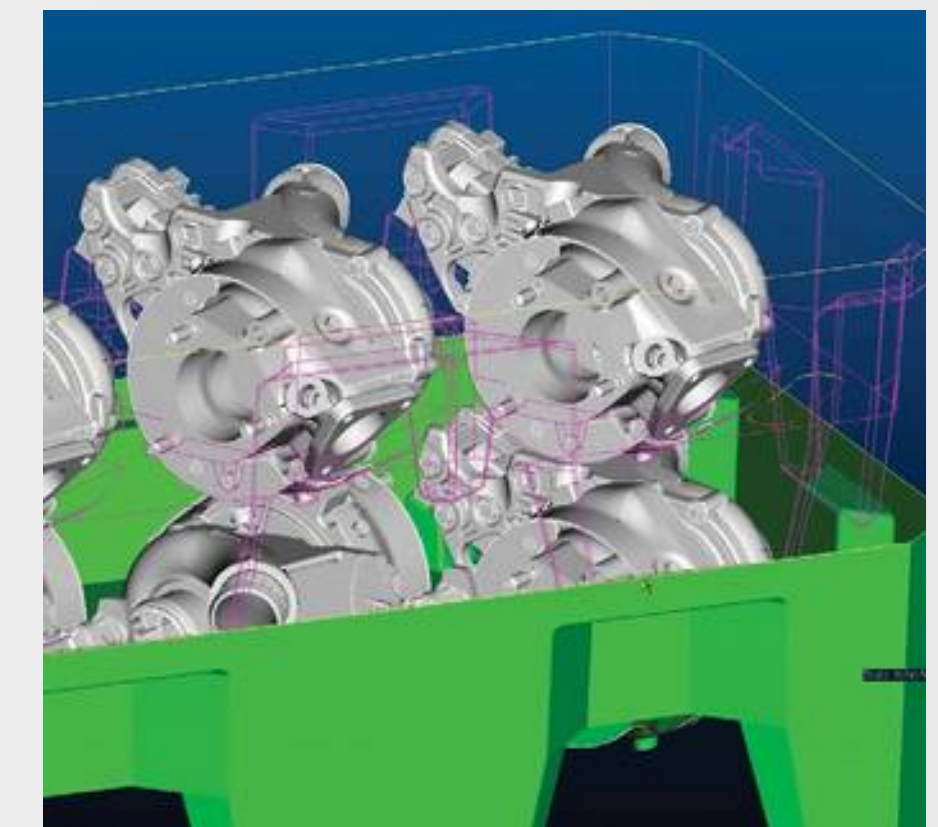
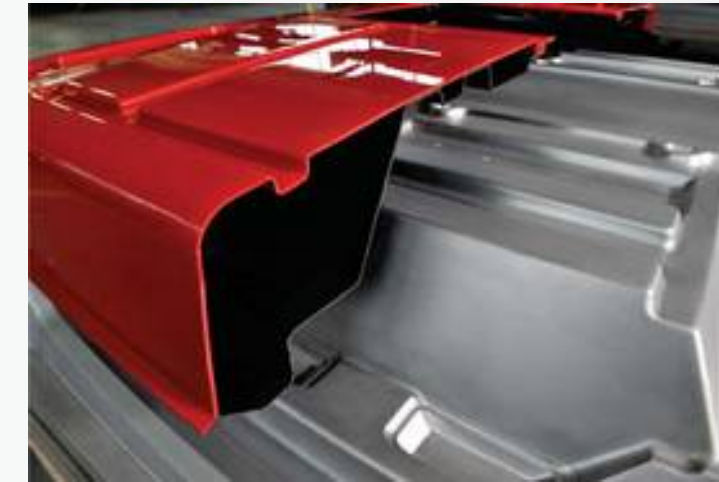

Architecture & Construction	light diffusers, skylights, floor panels, doors
Automotive & Heavy Duty Equipment	Exterior and interior vehicle components
Appliance	Refrigerators, freezers, vending machines
Bath & Wellness	Spas, bathtubs, hot tubs, showers, tub showers, sinks, tanning beds
Healthcare	Diagnostic systems, dental equipment, beds
Furniture & Lighting	Seats, Lamps
Industrial packaging	Pallets, trays, containers
Luggage	Hard shell suitcases, special cases
Machinery & industrial systems	Covers, shields, custom parts
Mass transportation	Exterior and interior vehicle components
Power generation	Wind mill covers, solar systems
Signage	Advertising signs, street signs, displays
Sport & Leisure	Canoes, kayaks, yet ski ,boats, surfs, golf carts, snowmobiles, ski lifts

With dedicated contact professionals we assure clear communications and rapid response to your requirements.



Lifetime support service

Always at your side throughout the complete life cycle of your product with our specialists and service partners network

Setup & Part qualification	To insure the project timeline is achieved	
Maintenance & Spare parts	To assure long life and non-stop manufacturing	
Process optimization	A dedicated specialist by your side to improve and innovate	
Upgrading & Modifications	Products and mould life evolve with us	
Training	Our network knowledge shared with you on or off site.	
Hot line	With pleasure for your urgent unforeseen needs all around the clock	



Contacts

SELF GROUP S.R.L.

- Via G. Bruno, 13 33061 Rivignano Teor (UD) – ITALY
- Tel. +39 0432 775144
- www.selfgroup.com
- business@selfmoulds.com

